

Bottom view

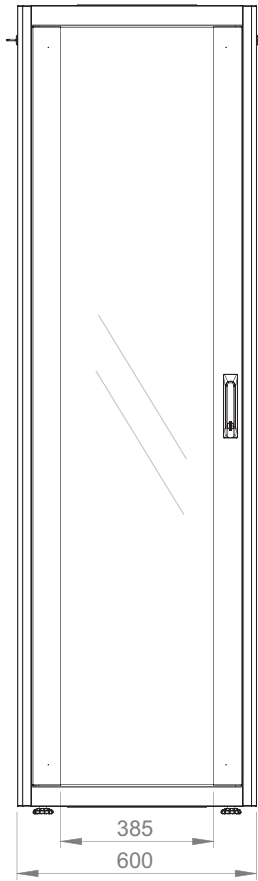

Front view

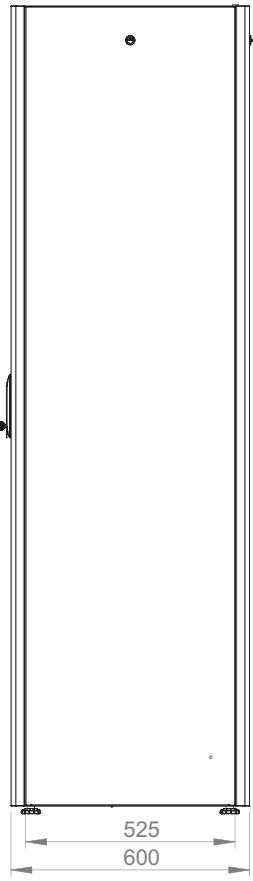

Side view

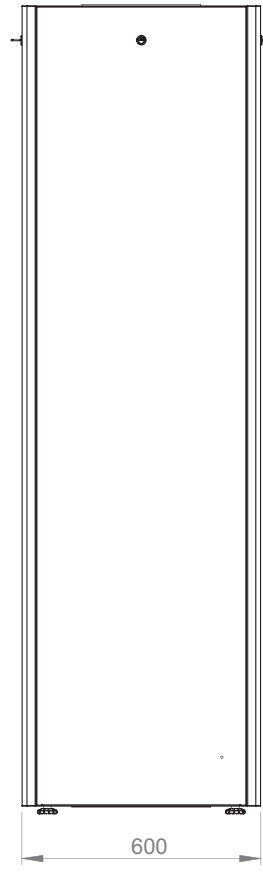

Rear view

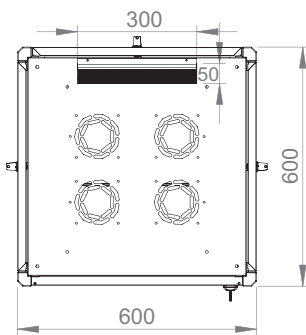

Top view

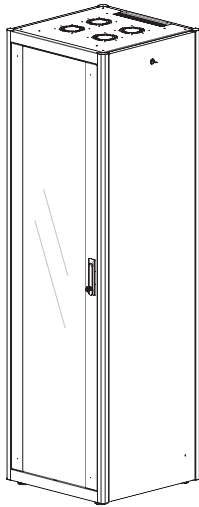

Isometric view

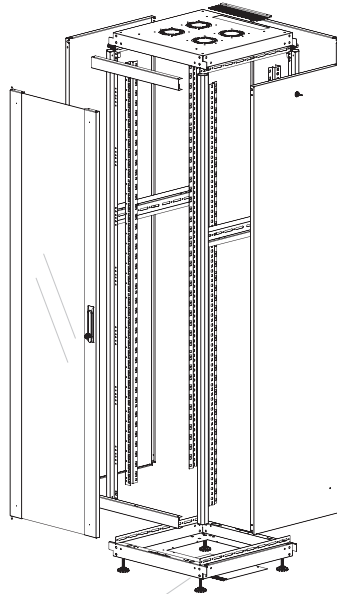

Exploded view

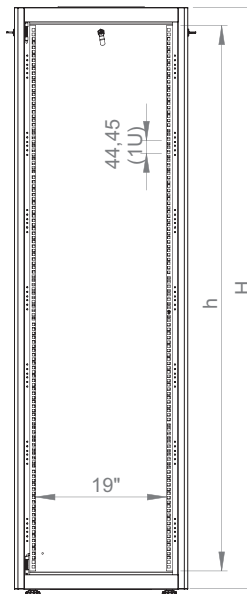

Dimensions in width and height

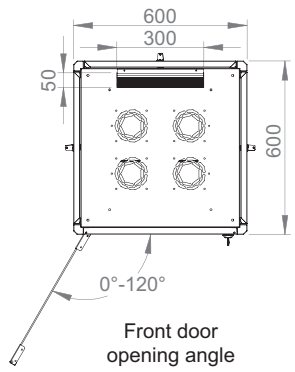
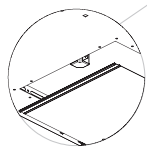

Front door opening angle

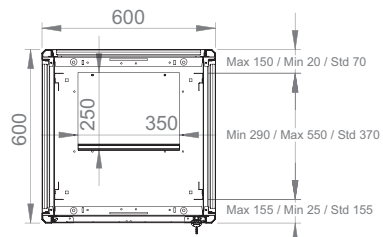

Max/std/min equipment mounting distance

	h	H
<b>22U</b>	978 mm	1125 mm
<b>26U</b>	1155 mm	1300 mm
<b>32U</b>	1422 mm	1560 mm
<b>36U</b>	1600 mm	1744 mm
<b>42U</b>	1867 mm	2010 mm
<b>47U</b>	2089 mm	2236 mm