

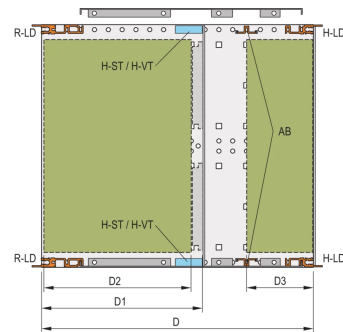

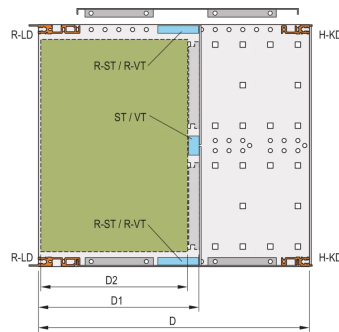

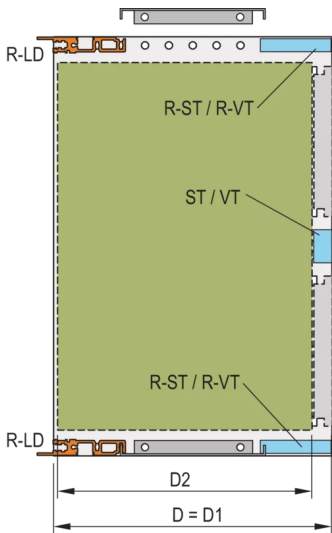

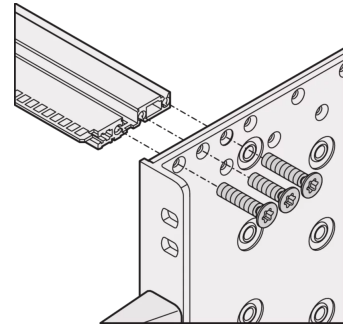
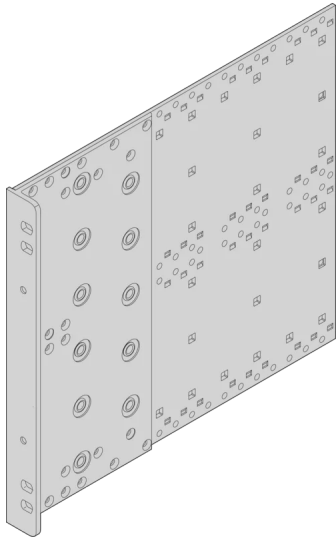

24568-444 EUROPACPRO SIDE PANEL FOR TEXTILE GASKET, TYPE R, 6 U, 277.75 MM



Combinations of horizontal rails and side panels

*+/- can be combined, +/- combinations not recommended

	-	+	+	+
	+	not recommended	not recommended	+
	+	+	-	-
	+	+	-	-

+ Recommended

KEY FEATURES

For high mechanical loads up to 25 g (vibration resistance, shock and vibration requirements e.g. IEC 61587-DL 3)

For high mechanical demands, 19" bracket 3,5mm and side panel 3mm, tox-cold welded together, clear passivated, front anodized

EMC shielding concept for front/rear with EMC textile gasket

Four mounting holes per 19" bracket provide improved stability when screwing the subrack into a cabinet or open frame rack

With holes for handle

PRODUCT ATTRIBUTES

Product Type: Side Panel

Product Family: EuropacPRO

Type: Type R

Rack Height: 6 U

Board Depth: 277.75 mm

Package Quantity: 1

Package Unit: Pair

Depth: 277.75 mm

ADDITIONAL PRODUCT DETAILS

Side Panel, Type R, tox welded to the 19" bracket for textile gasket, with handle holes and four fixing holes per 19" bracket.

Please order front handle separately.

Other dimensions on request.

Please order screws for mounting horizontal rails and top cover/base plate separately.

CERTIFICATIONS



North America

All locations

+1.763.422.2661

Chat with us:

schroff.nvent.com

Europe

Straubenhardt, Germany

+49.7082.794.0

Betschdorf, France

+33.3.88.90.64.90

Warsaw, Poland

+48.22.209.98.35

Assago, Italy

+39.02.932.7141

Chat with us:

schroff.nvent.com

Asia

Shanghai, China

+86.21.2412.6943

Qingdao, China

+86.532.8771.6101

Singapore

+65.6768.5800

Shin-Yokohama, Japan

+81.45.476.0271

Chat with us:

schroff.nvent.com

Middle East & India

Dubai, United Arab Emirates

+971.4.378.1700

Bangalore, India

+91.80.6715.2001

Istanbul, Turkey

+90.216.250.7374

Chat with us:

schroff.nvent.com



Our powerful portfolio of brands:
nVent.com **CADDY ERICO HOFFMAN RAYCHEM SCHROFF TRACER**

© 2023 nVent. All nVent marks and logos are owned or licensed by nVent Services GmbH or its affiliates. All other trademarks are the property of their respective owners.

nVent reserves the right to change specifications without notice.