

20713-979 INTERSCALE FAN FIXING CORD

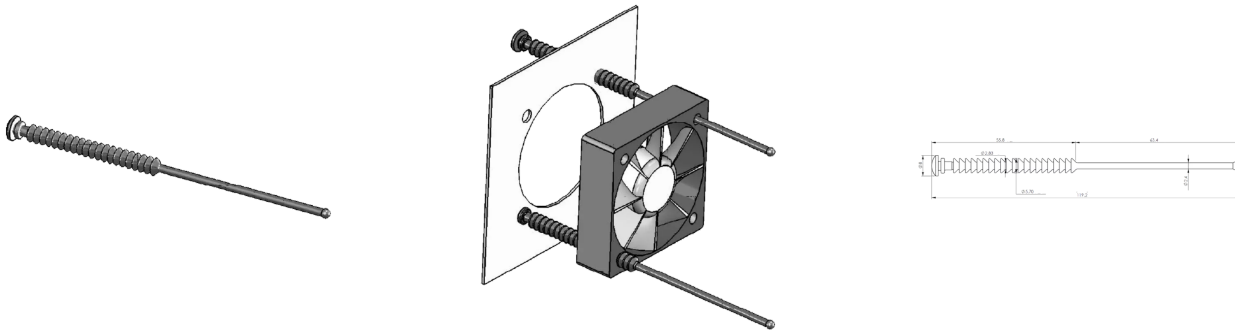

KEY FEATURES

Interscale Fan Fixing Cord, for vibration-damping fixation of fans in cases and chassis

Can be used for the assembly of fans with a hole for mounting diameter of 4.0 to 4.5 mm

The width of the fan can be 15 up to 50 mm

PRODUCT ATTRIBUTES

Product Type: Mounting Kit

Product Family: Interscale

Type: Gasket

Works With: Small Form Factor Cases

Material: Rubber

Package Quantity: 100

ADDITIONAL PRODUCT DETAILS

Interscale Fan Fixing Cord, for vibration-damping fixation of fans in cases and chassis.

North America

All locations

+1.763.422.2661

Chat with us:

schroff.nvent.com

Europe

Straubenhardt, Germany

+49.7082.794.0

Betschdorf, France

+33.3.88.90.64.90

Warsaw, Poland

+48.22.209.98.35

Assago, Italy

+39.02.932.7141

Chat with us:

schroff.nvent.com

Asia

Shanghai, China

+86.21.2412.6943

Qingdao, China

+86.532.8771.6101

Singapore

+65.6768.5800

Shin-Yokohama, Japan

+81.45.476.0271

Chat with us:

schroff.nvent.com

Middle East & India

Dubai, United Arab Emirates

+971.4.378.1700

Bangalore, India

+91.80.6715.2001

Istanbul, Turkey

+90.216.250.7374

Chat with us:

schroff.nvent.com



Our powerful portfolio of brands:
nVent.com **CADDY ERICO HOFFMAN RAYCHEM SCHROFF TRACER**

© 2023 nVent. All nVent marks and logos are owned or licensed by nVent Services GmbH or its affiliates. All other trademarks are the property of their respective owners.

nVent reserves the right to change specifications without notice.