

60224-009 PLASTIC FOOT FOR CASES, HEIGHT 7.2 MM

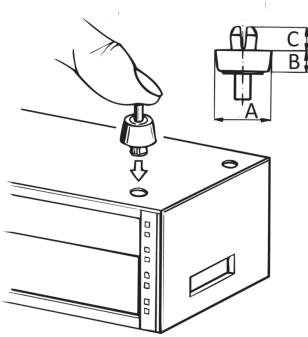

KEY FEATURES

Plastic foot

Easy assembly. Foot is inserted into mounting hole and then fixed by pressing in the expanding pin

PRODUCT ATTRIBUTES

Product Type: Foot

Type: Foot

Works With: Cases

Material: Polycarbonate

Flammability Rating: UL® 94V-0

Package Quantity: 50

ADDITIONAL PRODUCT DETAILS

The plastic feet can be mounted on the bottom cover of a case or chassis. Available in different heights.

CERTIFICATIONS



North America

All locations

+1.763.422.2661

Chat with us:

schroff.nvent.com

Europe

Straubenhardt, Germany

+49.7082.794.0

Betschdorf, France

+33.3.88.90.64.90

Warsaw, Poland

+48.22.209.98.35

Assago, Italy

+39.02.932.7141

Chat with us:

schroff.nvent.com

Asia

Shanghai, China

+86.21.2412.6943

Qingdao, China

+86.532.8771.6101

Singapore

+65.6768.5800

Shin-Yokohama, Japan

+81.45.476.0271

Chat with us:

schroff.nvent.com

Middle East & India

Dubai, United Arab Emirates

+971.4.378.1700

Bangalore, India

+91.80.6715.2001

Istanbul, Turkey

+90.216.250.7374

Chat with us:

schroff.nvent.com



Our powerful portfolio of brands:
nVent.com **CADDY ERICO HOFFMAN RAYCHEM SCHROFF TRACER**

© 2023 nVent. All nVent marks and logos are owned or licensed by nVent Services GmbH or its affiliates. All other trademarks are the property of their respective owners.

nVent reserves the right to change specifications without notice.