

34813-621 FRAME TYPE PLUG-IN UNIT FRONT PANEL, REFROFIT SHIELDING, 6 U, 21 HP, 2.5 MM, AL, FRONT ANODIZED, REAR CONDUCTIVE

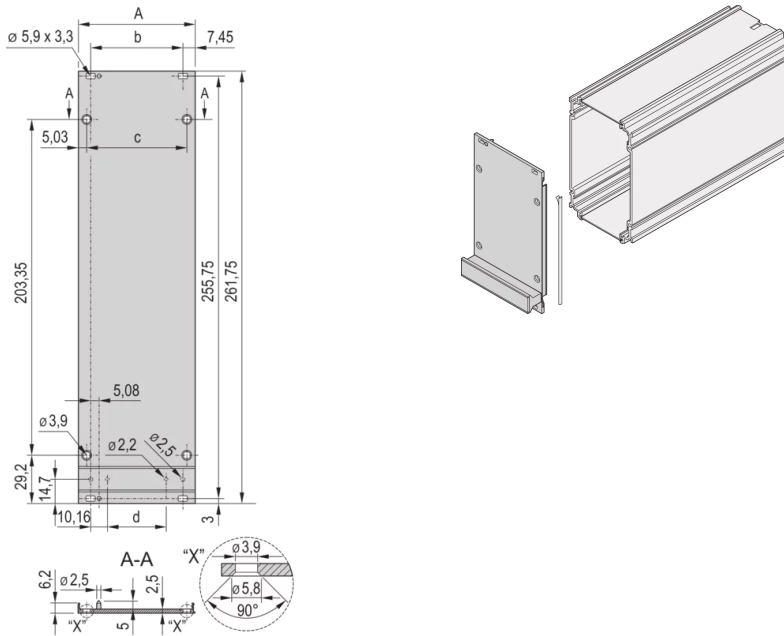

**KEY FEATURES**

Front Panel for frame type plug-in units PRO, can be modified with Front Panel Configurator

Al extrusion, alignment pin pressed-in, front-anodized, rear conductive

**PRODUCT ATTRIBUTES**

Accessory Type: Front panel

Material: Aluminum

Front Finish: Anodized

Rear Finish: Conductive

Treated Edges: No

Rack Height: 6 U

Rack Width: 21 HP

Height: 261.75 mm

Width: 106.34 mm

Depth: 2.5 mm

Package Quantity: 5

## ADDITIONAL PRODUCT DETAILS

---

Front Panel for frame type plug-in unit, shieldable.

Please take into consideration that deliveries may be carried out in the stated SPQs (SPQ, e.g. 5 pieces, 10 pieces, 50 pieces, etc.). Differing order quantities (e.g. 2 pieces) may be changed to the next possible delivery quantity = Standard Pack Quantity.

Mounting kit to fix front Panel to plug-in unit, handle to bolt on, clip and screw with plastic sleeve for mounting plug-in unit in subrack or case are included in the item 'Mounting kit for five plug-in units', part number 24812-100.

## CERTIFICATIONS

---



### North America

All locations  
+1.763.422.2661  
Chat with us:  
[schroff.nvent.com](https://schroff.nvent.com)

### Europe

Straubenhardt, Germany  
+49.7082.794.0  
Betschdorf, France  
+33.3.88.90.64.90  
Warsaw, Poland  
+48.22.209.98.35  
Assago, Italy  
+39.02.932.7141  
Chat with us:  
[schroff.nvent.com](https://schroff.nvent.com)

### Asia

Shanghai, China  
+86.21.2412.6943  
Qingdao, China  
+86.532.8771.6101  
Singapore  
+65.6768.5800  
Shin-Yokohama, Japan  
+81.45.476.0271  
Chat with us:  
[schroff.nvent.com](https://schroff.nvent.com)

### Middle East & India

Dubai, United Arab Emirates  
+971.4.378.1700  
Bangalore, India  
+91.80.6715.2001  
Istanbul, Turkey  
+90.216.250.7374  
Chat with us:  
[schroff.nvent.com](https://schroff.nvent.com)



Our powerful portfolio of brands:  
[nVent.com](https://nVent.com) **CADDY ERICO HOFFMAN RAYCHEM SCHROFF TRACER**

© 2023 nVent. All nVent marks and logos are owned or licensed by nVent Services GmbH or its affiliates. All other trademarks are the property of their respective owners.

nVent reserves the right to change specifications without notice.