

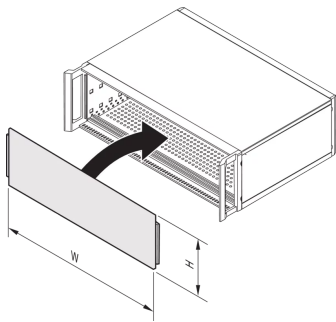

SCHROFF

34571-620 FRONT PANEL, FULL WIDTH, SLOTTED, UNSHIELDED FOR RATIOACPRO 2 U, AIR 3 U, 84 HP, 2.5 MM, AL, FRONT ANODIZED, REAR CONDUCTIVE



KEY FEATURES

Inserted between side panel and molded parts such as trim, 19" mounting bracket or handle

Front panels can also be used as rear panels

Fixes without screws (special horizontal rails cover the edges of the front panel and hold them in place)

Shielded (rear conductive); for a conductive connection with the case please order EMC sealing (stainless steel) separately

PRODUCT ATTRIBUTES

Accessory Type: Front panel

Material: Aluminum

Front Finish: Anodized

Rear Finish: Conductive

Treated Edges: No

Rack Height: 2 U

Height: 84 mm

Rack Width: 84 HP

Width: 426.4 mm

Depth: 2.5 mm

Package Quantity: 1

ADDITIONAL PRODUCT DETAILS

Full width, slotted, unshielded front panel for RatiopacPRO/-AIR.

CERTIFICATIONS



North America

All locations
+1.763.422.2661
Chat with us:
schroff.nvent.com

Europe

Straubenhardt, Germany
+49.7082.794.0
Betschdorf, France
+33.3.88.90.64.90
Warsaw, Poland
+48.22.209.98.35
Assago, Italy
+39.02.932.7141
Chat with us:
schroff.nvent.com

Asia

Shanghai, China
+86.21.2412.6943
Qingdao, China
+86.532.8771.6101
Singapore
+65.6768.5800
Shin-Yokohama, Japan
+81.45.476.0271
Chat with us:
schroff.nvent.com

Middle East & India

Dubai, United Arab Emirates
+971.4.378.1700
Bangalore, India
+91.80.6715.2001
Istanbul, Turkey
+90.216.250.7374
Chat with us:
schroff.nvent.com



Our powerful portfolio of brands:
nVent.com **CADDY ERICO HOFFMAN RAYCHEM SCHROFF TRACER**

© 2023 nVent. All nVent marks and logos are owned or licensed by nVent Services GmbH or its affiliates. All other trademarks are the property of their respective owners.

nVent reserves the right to change specifications without notice.