

30849-749 U-PROFILE FRONT PANEL, SHIELDABLE, D-SUB CUTOUT, 3 U, 4 HP, 1 X 9 PIN, 2.5 MM, AL, FRONT ANODIZED, REAR CONDUCTIVE

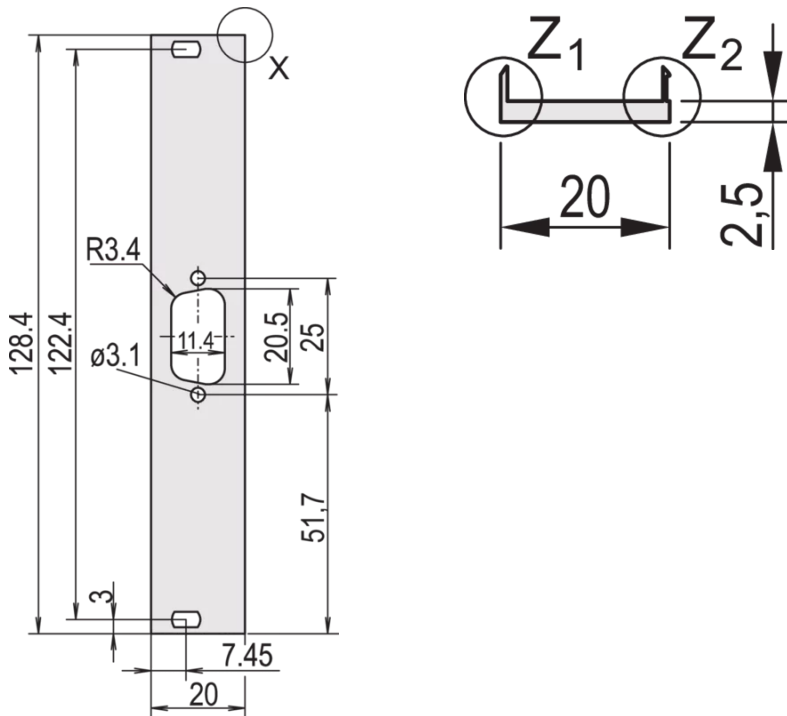

KEY FEATURES

U-profile, front panel, Al, 2.5 mm, front anodized, rear conductive

For EMC textile gasket

PRODUCT ATTRIBUTES

Type: Front Panel without Handle

Accessory Type: Front panel

Mounting: Screw-on Front

EMC Shielding: No (Retrofittable)

EMC Gasket Type: Textile

Material: Aluminum

Front Finish: Anodized

Rear Finish: Conductive

Treated Edges: No

Rack Height: 3 U

Rack Width: 4 HP

Height: 128.4 mm

Width: 20 mm

Depth: 2.5 mm

Complies With: IEC 60297-3-101; IEEE 1101.1/10

Package Quantity: 5

ADDITIONAL PRODUCT DETAILS

U-profile front panel with cutout for D-Sub connectors. Shieldable for textile EMC gasket.

Please order fixing material (sleeves, collar screws) separately.

Delivery is in standard pack multiples. Pricing is per individual item.

Please order textile EMC gasket separately.

Please take into consideration that deliveries may be carried out in the stated SPQs (SPQ, e.g. 5 pieces, 10 pieces, 50 pieces, etc.). Differing order quantities (e.g. 2 pieces) may be changed to the next possible delivery quantity = Standard Pack Quantity.

CERTIFICATIONS



North America

All locations

+1.763.422.2661

Chat with us:

schroff.nvent.com

Europe

Straubenhardt, Germany

+49.7082.794.0

Betschdorf, France

+33.3.88.90.64.90

Warsaw, Poland

+48.22.209.98.35

Assago, Italy

+39.02.932.7141

Chat with us:

schroff.nvent.com

Asia

Shanghai, China

+86.21.2412.6943

Qingdao, China

+86.532.8771.6101

Singapore

+65.6768.5800

Shin-Yokohama, Japan

+81.45.476.0271

Chat with us:

schroff.nvent.com

Middle East & India

Dubai, United Arab Emirates

+971.4.378.1700

Bangalore, India

+91.80.6715.2001

Istanbul, Turkey

+90.216.250.7374

Chat with us:

schroff.nvent.com



Our powerful portfolio of brands:
nVent.com **CADDY ERICO HOFFMAN RAYCHEM SCHROFF TRACER**

© 2023 nVent. All nVent marks and logos are owned or licensed by nVent Services GmbH or its affiliates. All other trademarks are the property of their respective owners.

nVent reserves the right to change specifications without notice.