

30849-090 PLUG-IN UNIT U-PROFILE FRONT PANEL FOR STATIC TRAPEZOID HANDLE, 3 U, 7 HP, 2.5 MM, AL, FRONT ANODIZED, REAR CONDUCTIVE

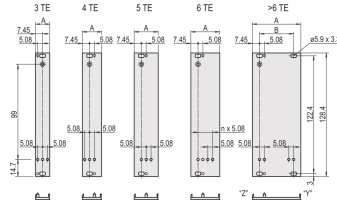
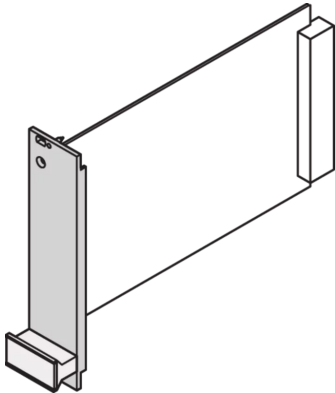

KEY FEATURES

Al extrusion, front anodized, rear conductive, alignment pin pressed-in, stainless steel

Front panel, U-profile, shieldable

PRODUCT ATTRIBUTES

Type: Front Panel for Handle (PIU)

Accessory Type: Front panel

Handle Type: Trapezoid, Static; Aluminum Profile

Mounting: Screw-on Front

EMC Shielding: No (Retrofittable)

EMC Gasket Type: Textile

Material: Aluminum

Front Finish: Anodized

Rear Finish: Conductive

Treated Edges: No

Rack Height: 3 U

Rack Width: 7 HP

Height: 128.4 mm

Width: 35.2 mm

Depth: 2.5 mm

Complies With: IEC 60297-3-101

Package Quantity: 5

ADDITIONAL PRODUCT DETAILS

U-profile front panel. Enables the assembly of a plastic or Alu-profile static trapezoid handle. The front panel can be shielded with a textile gasket.

Please order EMC profile seal separately.

Please take into consideration that deliveries may be carried out in the stated SPQs (SPQ, e.g. 5 pieces, 10 pieces, 50 pieces, etc.). Differing order quantities (e.g. 2 pieces) may be changed to the next possible delivery quantity = Standard Pack Quantity.

CERTIFICATIONS



North America

All locations
+1.763.422.2661
Chat with us:
schroff.nvent.com

Europe

Straubenhardt, Germany
+49.7082.794.0
Betschdorf, France
+33.3.88.90.64.90
Warsaw, Poland
+48.22.209.98.35
Assago, Italy
+39.02.932.7141
Chat with us:
schroff.nvent.com

Asia

Shanghai, China
+86.21.2412.6943
Qingdao, China
+86.532.8771.6101
Singapore
+65.6768.5800
Shin-Yokohama, Japan
+81.45.476.0271
Chat with us:
schroff.nvent.com

Middle East & India

Dubai, United Arab Emirates
+971.4.378.1700
Bangalore, India
+91.80.6715.2001
Istanbul, Turkey
+90.216.250.7374
Chat with us:
schroff.nvent.com



Our powerful portfolio of brands:
nVent.com **CADDY ERICO HOFFMAN RAYCHEM SCHROFF TRACER**

© 2023 nVent. All nVent marks and logos are owned or licensed by nVent Services GmbH or its affiliates. All other trademarks are the property of their respective owners.

nVent reserves the right to change specifications without notice.