

30847-628 PLUG-IN UNIT FRONT PANEL, UNSHIELDED, FOR STATIC TRAPEZOID HANDLE, 6 U, 6 HP, 2.5 MM, AL, FRONT ANODIZED, REAR CONDUCTIVE

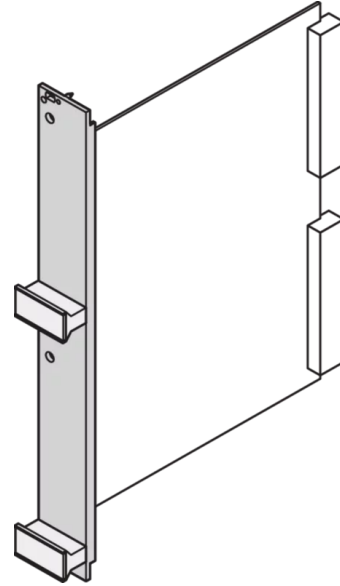
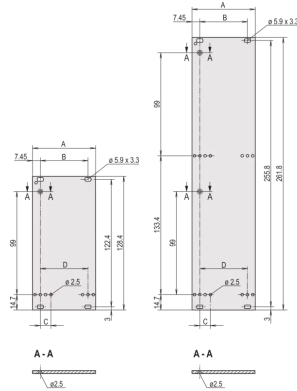

KEY FEATURES

Front panel, unshielded

Front panel, Al, 2.5 mm, front anodized, conductive

PRODUCT ATTRIBUTES

Type: Front Panel for Handle (PIU)

Accessory Type: Front panel

Handle Type: Trapezoid, Static; Aluminum Profile

Mounting: Screw-on Front

EMC Shielding: No

Material: Aluminum

Front Finish: Anodized

Rear Finish: Conductive

Treated Edges: No

Rack Height: 6 U

Rack Width: 6 HP

Height: 261.8 mm

Width: 30.1 mm

Depth: 2.5 mm

Complies With: IEC 60297-3-101

Package Quantity: 5

ADDITIONAL PRODUCT DETAILS

The front panel enables the assembly of a plastic or Alu-profile static trapezoid handle. The front panel cannot be shielded with a textile gasket.

CERTIFICATIONS



North America

All locations

+1.763.422.2661

Chat with us:

schroff.nvent.com

Europe

Straubenhardt, Germany

+49.7082.794.0

Betschdorf, France

+33.3.88.90.64.90

Warsaw, Poland

+48.22.209.98.35

Assago, Italy

+39.02.932.7141

Chat with us:

schroff.nvent.com

Asia

Shanghai, China

+86.21.2412.6943

Qingdao, China

+86.532.8771.6101

Singapore

+65.6768.5800

Shin-Yokohama, Japan

+81.45.476.0271

Chat with us:

schroff.nvent.com

Middle East & India

Dubai, United Arab Emirates

+971.4.378.1700

Bangalore, India

+91.80.6715.2001

Istanbul, Turkey

+90.216.250.7374

Chat with us:

schroff.nvent.com



Our powerful portfolio of brands:
nVent.com **CADDY ERICO HOFFMAN RAYCHEM SCHROFF TRACER**

© 2023 nVent. All nVent marks and logos are owned or licensed by nVent Services GmbH or its affiliates. All other trademarks are the property of their respective owners.

nVent reserves the right to change specifications without notice.