

22117-980 EURORACK 19" CABINET FRAME, 25 U 600W 800D

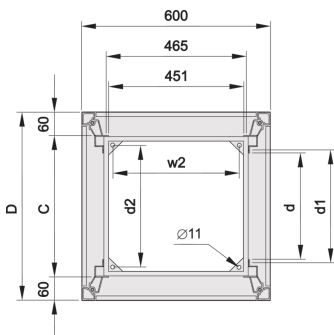
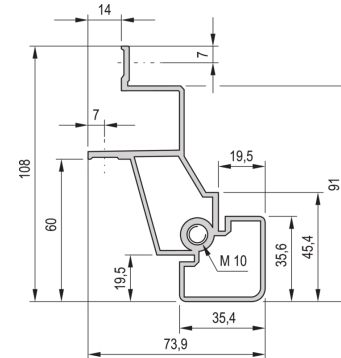
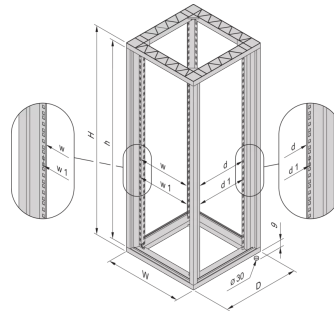
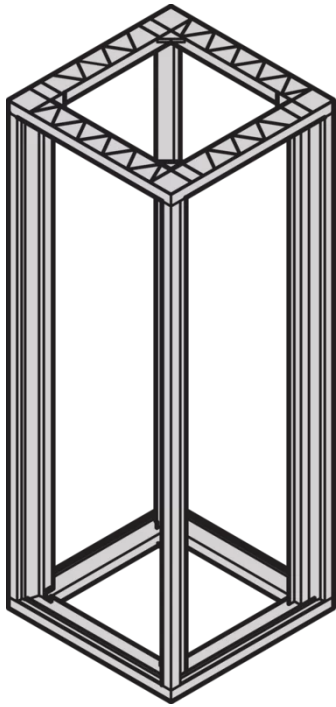

KEY FEATURES

Bolted, frame Al diecast, upright Al extrusion

Fixed spacing between front and rear 19" plane

Finish: RAL 7021

PRODUCT ATTRIBUTES

Product Type: Cabinet/Rack Frame

Product Family: Eurorack

Type: Standard

Frame Material: Aluminum

Color: Black Grey

Color Code: RAL 7021

Rack Height: 25 U

Height: 1220 mm

Width: 600 mm

Depth: 800 mm

Static Load: 400 kg

ADDITIONAL PRODUCT DETAILS

Fixed spacing between front and rear 19" plane.

CERTIFICATIONS



North America

All locations
+1.763.422.2661
Chat with us:
schroff.nvent.com

Europe

Straubenhardt, Germany
+49.7082.794.0
Betschdorf, France
+33.3.88.90.64.90
Warsaw, Poland
+48.22.209.98.35
Assago, Italy
+39.02.932.7141
Chat with us:
schroff.nvent.com

Asia

Shanghai, China
+86.21.2412.6943
Qingdao, China
+86.532.8771.6101
Singapore
+65.6768.5800
Shin-Yokohama, Japan
+81.45.476.0271
Chat with us:
schroff.nvent.com

Middle East & India

Dubai, United Arab Emirates
+971.4.378.1700
Bangalore, India
+91.80.6715.2001
Istanbul, Turkey
+90.216.250.7374
Chat with us:
schroff.nvent.com



Our powerful portfolio of brands:
nVent.com **CADDY ERICO HOFFMAN RAYCHEM SCHROFF TRACER**

© 2023 nVent. All nVent marks and logos are owned or licensed by nVent Services GmbH or its affiliates. All other trademarks are the property of their respective owners.

nVent reserves the right to change specifications without notice.