

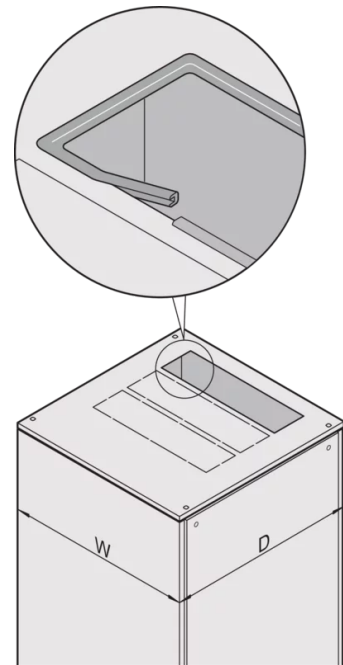

SCHROFF

21130-252 VARISTAR FLAT TOP COVER WITH CUTOUT ZONES, RAL 7021, 600W
600D

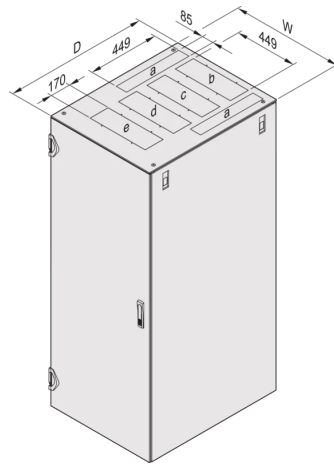
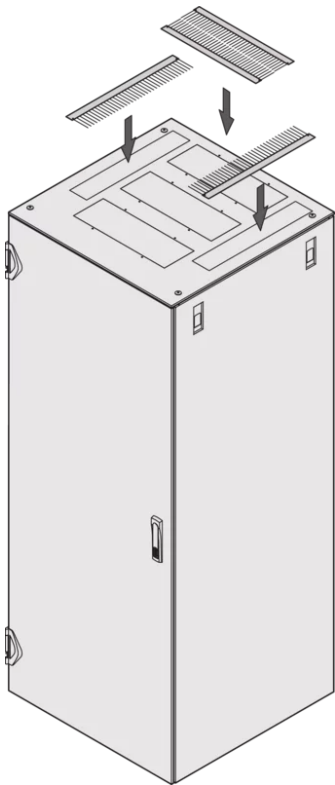
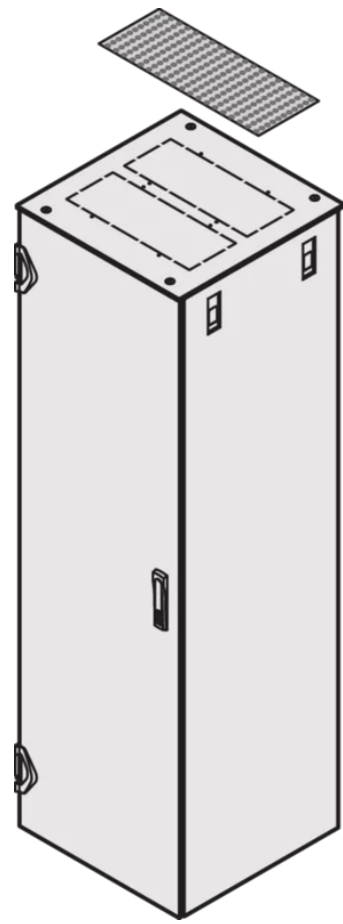
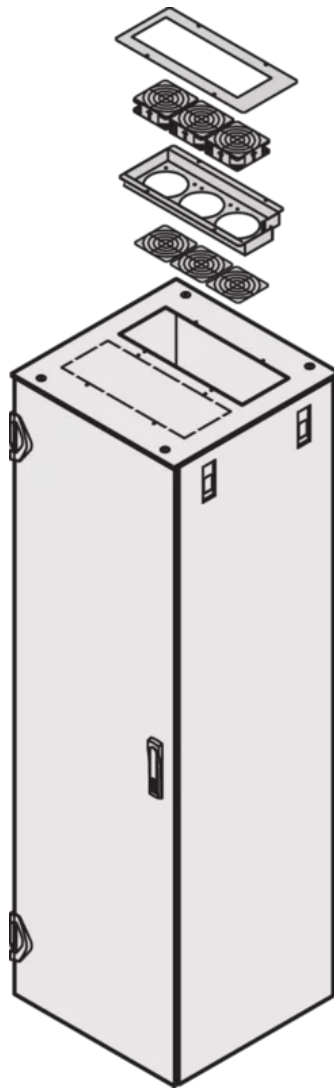
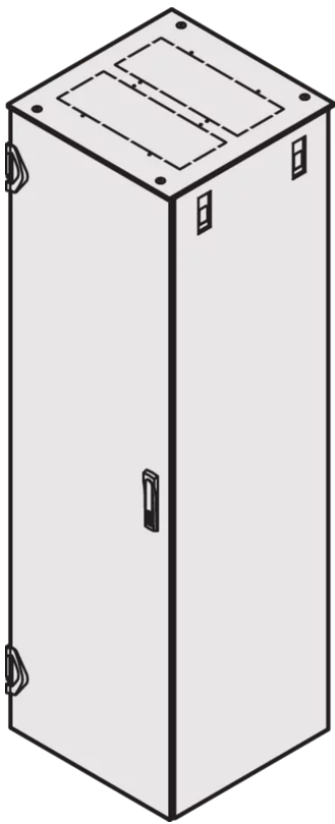

KEY FEATURES

Incl. GND/grounding

Cut-out zones are easy to cut out

St, 1.5 mm

Cut-outs can be fitted with brush strips, fan units, perforated cover plates or edge protectors

Color RAL 7021

PRODUCT ATTRIBUTES

Product Type: Cabinet/Rack Top Cover

Product Family: Varistar

Type: Cutout

Material: Steel

Color: Black Grey

Color Code: RAL 7021

Width: 600 mm

Depth: 600 mm

ADDITIONAL PRODUCT DETAILS

Rack top cover with micro perforated break off cut out zones. Brushes, edge protection or cover panle have to chosen form the accessory range.

Dimensions see attachments Varistar platform catalog.

CERTIFICATIONS



North America

All locations

+1.763.422.2661

Chat with us:

schroff.nvent.com

Europe

Straubenhardt, Germany

+49.7082.794.0

Betschdorf, France

+33.3.88.90.64.90

Warsaw, Poland

+48.22.209.98.35

Assago, Italy

+39.02.932.7141

Chat with us:

schroff.nvent.com

Asia

Shanghai, China

+86.21.2412.6943

Qingdao, China

+86.532.8771.6101

Singapore

+65.6768.5800

Shin-Yokohama, Japan

+81.45.476.0271

Chat with us:

schroff.nvent.com

Middle East & India

Dubai, United Arab Emirates

+971.4.378.1700

Bangalore, India

+91.80.6715.2001

Istanbul, Turkey

+90.216.250.7374

Chat with us:

schroff.nvent.com



Our powerful portfolio of brands:
nVent.com **CADDY ERICO HOFFMAN RAYCHEM SCHROFF TRACER**

© 2023 nVent. All nVent marks and logos are owned or licensed by nVent Services GmbH or its affiliates. All other trademarks are the property of their respective owners.

nVent reserves the right to change specifications without notice.