

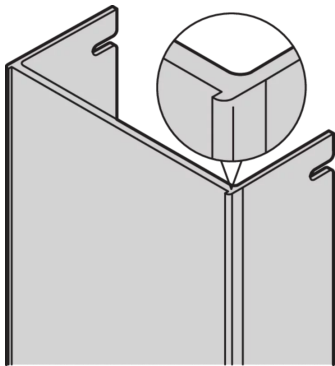

SCHROFF

20849-251 AMC FILLER MODULE WITH PULL-HANDLE, DOUBLE FULL-SIZE, ALUMINUM

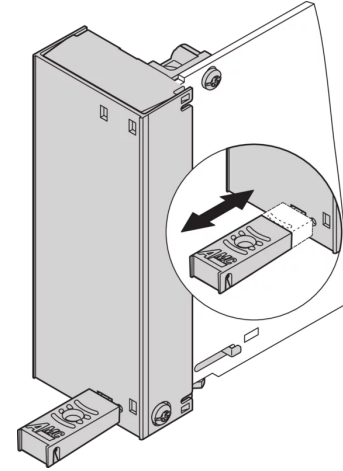
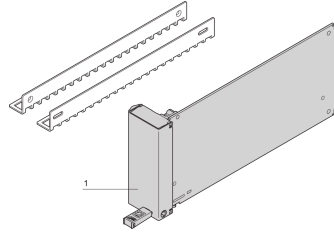

KEY FEATURES

In accordance with AMC.0 R2.0 specification

Shielded filler modules are used to close unused slots

pull handle to extract sub-assembly

The optional air baffle (airflow adjustable) can be used to direct chassis airflow

PRODUCT ATTRIBUTES

Product Type: System Module

Product Family: AdvancedMC

Type: Filler Module

Material: Aluminum

ADDITIONAL PRODUCT DETAILS

This AdvancedMC filler module consists of a stainless steel front panel without LEDs and has EMC gaskets on the left hand and bottom side. The filler module is fixed into the chassis card guide by a snap in plastic nose. The module can be used to cover an empty slot, to ensure EMC shielding and close the front to seal air leaks into the chassis. These filler modules can be used in AdvancedMC Carriers and in MicroTCA slots. It doesn't require a locking bar.

CERTIFICATIONS



North America

All locations
+1.763.422.2661
Chat with us:
schroff.nvent.com

Europe

Straubenhardt, Germany
+49.7082.794.0
Betschdorf, France
+33.3.88.90.64.90
Warsaw, Poland
+48.22.209.98.35
Assago, Italy
+39.02.932.7141
Chat with us:
schroff.nvent.com

Asia

Shanghai, China
+86.21.2412.6943
Qingdao, China
+86.532.8771.6101
Singapore
+65.6768.5800
Shin-Yokohama, Japan
+81.45.476.0271
Chat with us:
schroff.nvent.com

Middle East & India

Dubai, United Arab Emirates
+971.4.378.1700
Bangalore, India
+91.80.6715.2001
Istanbul, Turkey
+90.216.250.7374
Chat with us:
schroff.nvent.com



Our powerful portfolio of brands:
nVent.com **CADDY ERICO HOFFMAN RAYCHEM SCHROFF TRACER**

© 2023 nVent. All nVent marks and logos are owned or licensed by nVent Services GmbH or its affiliates. All other trademarks are the property of their respective owners.

nVent reserves the right to change specifications without notice.