

20838-098 HF FRAME TYPE PLUG-IN UNIT FRONT PANEL, REFROFIT SHIELDING WITH STEEL GASKET, 3 U, 28 HP

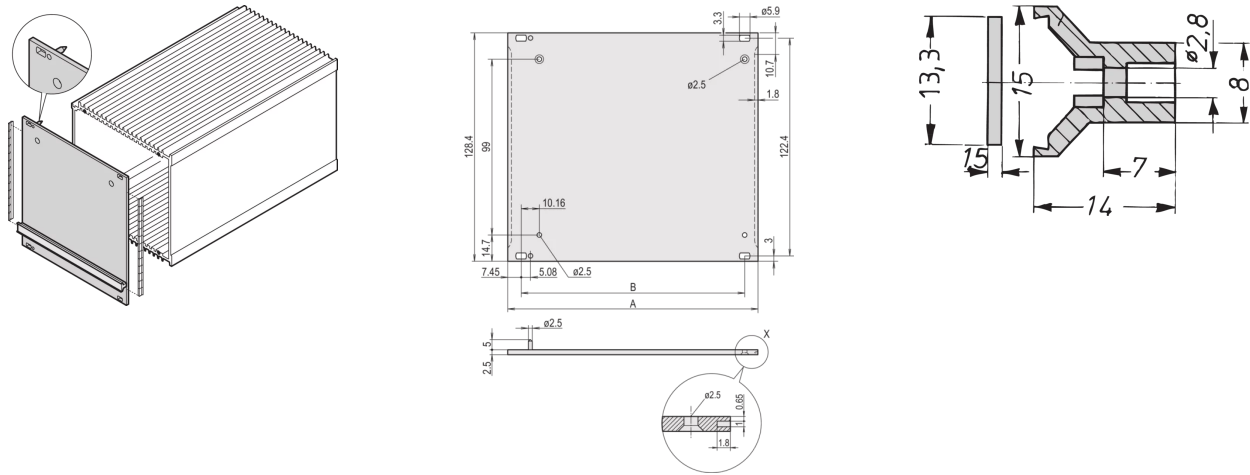

KEY FEATURES

Al, 2.5 mm, front anodized, rear conductive, with lateral slots for EMC stainless steel gasket (please order separately), pressed-in alignment pin;-trapezium shaped handle,-gray, PPE, UL-94 V-1

Front Panel with handle to bolt onto HF plug-in unit

PRODUCT ATTRIBUTES

Product Type: Side Panel

Type: Front Panel

Rack Height: 3 U

Rack Width: 28 HP

Package Quantity: 5

ADDITIONAL PRODUCT DETAILS

Al, 2.5 mm, front anodized, rear conductive, with lateral slots for EMC stainless steel gasket. (please order separately), pressed-in alignment pin;-trapezium shaped handle,-gray, PPE, UL-94 V-1.

Please take into consideration that deliveries may be carried out in the stated SPQs (SPQ, e.g. 5 pieces, 10 pieces, 50 pieces, etc.). Differing order quantities (e.g. 2 pieces) may be changed to the next possible delivery quantity = Standard Pack Quantity.



North America

All locations
+1.763.422.2661
Chat with us:
schroff.nvent.com

Europe

Straubenhardt, Germany
+49.7082.794.0
Betschdorf, France
+33.3.88.90.64.90
Warsaw, Poland
+48.22.209.98.35
Assago, Italy
+39.02.932.7141
Chat with us:
schroff.nvent.com

Asia

Shanghai, China
+86.21.2412.6943
Qingdao, China
+86.532.8771.6101
Singapore
+65.6768.5800
Shin-Yokohama, Japan
+81.45.476.0271
Chat with us:
schroff.nvent.com

Middle East & India

Dubai, United Arab Emirates
+971.4.378.1700
Bangalore, India
+91.80.6715.2001
Istanbul, Turkey
+90.216.250.7374
Chat with us:
schroff.nvent.com



Our powerful portfolio of brands:
nVent.com **CADDY ERICO HOFFMAN RAYCHEM SCHROFF TRACER**