

20130-629 VARISTAR CABINET FRAME, HEAVY DUTY, SEISMIC, 2000H 600W 600D

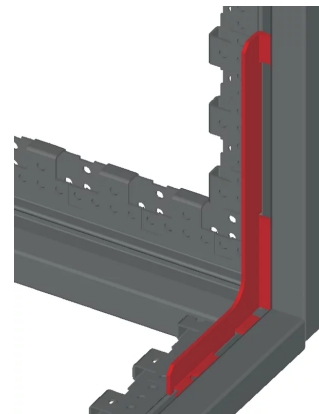
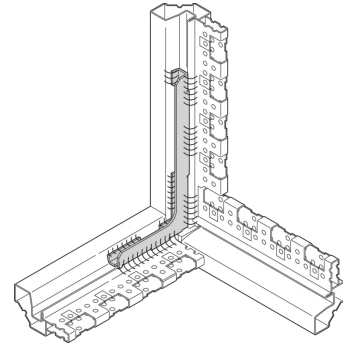
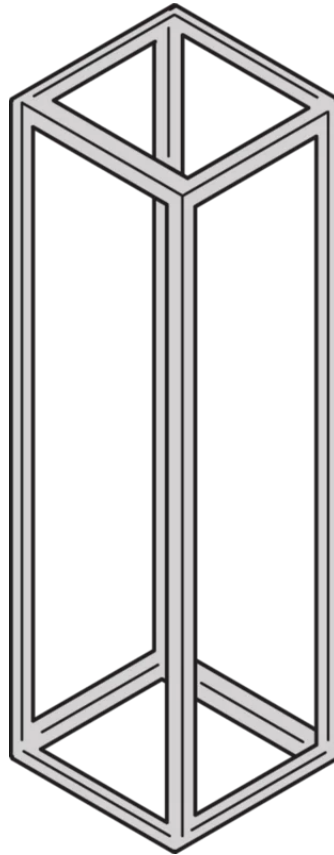

KEY FEATURES

St, 1.5 mm, zinc-plated, finish: powder-coated

Earthquake resistance to Bellcore Zone 4

Welded heavy-duty frame with strengthening brackets,-RAL 7021

Static load-carrying capacity 800-kg to IEC-61587-1 and IEC-61587-2

Dynamic load-carrying capacity 250-kg to IEC 61587-2

PRODUCT ATTRIBUTES

Product Type: Cabinet/Rack Frame

Product Family: Varistar

Type: Heavy Duty

Material: Steel

Frame Material: Steel

Color: Black Grey

Color Code: RAL 7021

Height: 2000 mm

Width: 600 mm

Depth: 600 mm

Static Load: 800 kg

Complies With: IEC 61587-1; IEC 61587-2

Shock and Vibration Tolerance: 1 g (force)

ADDITIONAL PRODUCT DETAILS

Welded, steel enclosure engineered specifically to protect equipment in areas with seismic activity and satisfy Bellcore Zore 4 requirements.

Please order attachments and components separately.

CERTIFICATIONS



North America

All locations

+1.763.422.2661

Chat with us:

schroff.nvent.com

Europe

Straubenhardt, Germany

+49.7082.794.0

Betschdorf, France

+33.3.88.90.64.90

Warsaw, Poland

+48.22.209.98.35

Assago, Italy

+39.02.932.7141

Chat with us:

schroff.nvent.com

Asia

Shanghai, China

+86.21.2412.6943

Qingdao, China

+86.532.8771.6101

Singapore

+65.6768.5800

Shin-Yokohama, Japan

+81.45.476.0271

Chat with us:

schroff.nvent.com

Middle East & India

Dubai, United Arab Emirates

+971.4.378.1700

Bangalore, India

+91.80.6715.2001

Istanbul, Turkey

+90.216.250.7374

Chat with us:

schroff.nvent.com



Our powerful portfolio of brands:
nVent.com **CADDY ERICO HOFFMAN RAYCHEM SCHROFF TRACER**

© 2023 nVent. All nVent marks and logos are owned or licensed by nVent Services GmbH or its affiliates. All other trademarks are the property of their respective owners.

nVent reserves the right to change specifications without notice.