

20130-589 VARISTAR CABINET FRAME, HEAVY-DUTY, 1200H 600W 1200D

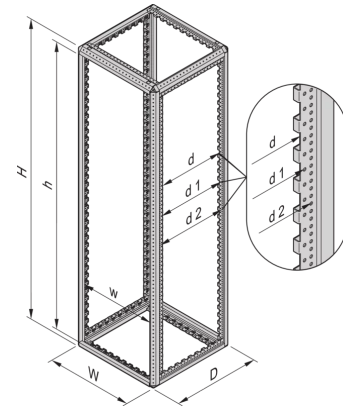
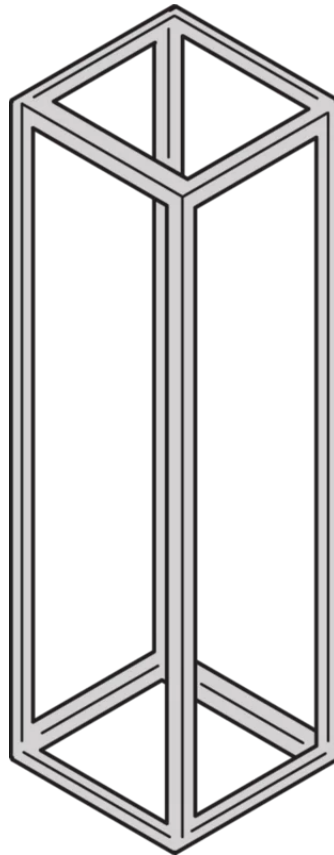
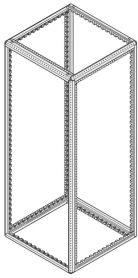

KEY FEATURES

St-1.5 mm, zinc-plated, with central GND/grounding point

Welded, finish powder-coated, black gray, RAL 7021

Static load-carrying capacity 800 kg

Please order adjustable feet or castors separately

PRODUCT ATTRIBUTES

Product Type: Cabinet/Rack Frame

Product Family: Varistar

Type: Heavy Duty

Material: Steel

Frame Material: Steel

Color: Black Grey

Color Code: RAL 7021

Rack Height: 24 U

Height: 1200 mm

Width: 600 mm

Depth: 1200 mm

Complies With: IEC 61587-1; IEC 61587-2; IEC 61587-3

ADDITIONAL PRODUCT DETAILS

Varistar welded steel frame for dynamic or seismic requirements. For 19" or mounting plate integration. Frame can be upgraded for IP 55 or EMC applications.

CERTIFICATIONS



North America

All locations

+1.763.422.2661

Chat with us:

schroff.nvent.com

Europe

Straubenhardt, Germany

+49.7082.794.0

Betschdorf, France

+33.3.88.90.64.90

Warsaw, Poland

+48.22.209.98.35

Assago, Italy

+39.02.932.7141

Chat with us:

schroff.nvent.com

Asia

Shanghai, China

+86.21.2412.6943

Qingdao, China

+86.532.8771.6101

Singapore

+65.6768.5800

Shin-Yokohama, Japan

+81.45.476.0271

Chat with us:

schroff.nvent.com

Middle East & India

Dubai, United Arab Emirates

+971.4.378.1700

Bangalore, India

+91.80.6715.2001

Istanbul, Turkey

+90.216.250.7374

Chat with us:

schroff.nvent.com



Our powerful portfolio of brands:
nVent.com **CADDY ERICO HOFFMAN RAYCHEM SCHROFF TRACER**

© 2023 nVent. All nVent marks and logos are owned or licensed by nVent Services GmbH or its affiliates. All other trademarks are the property of their respective owners.

nVent reserves the right to change specifications without notice.