

20100-018 BUSBAR WITH FASTON CONNECTIONS, 3 POLE, E-CU TIN-PLATED

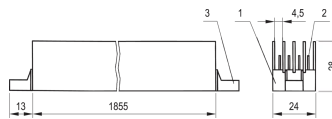
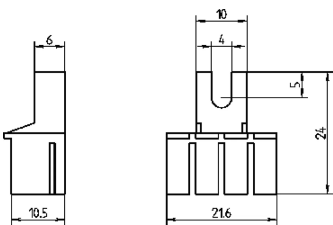
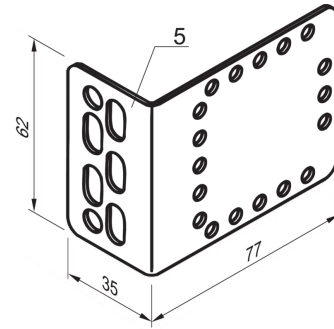
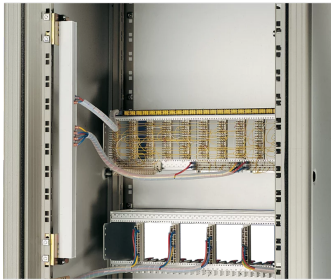

KEY FEATURES

- Connections FASTON 6.3 x 0.8 mm
- Can be sawn off to required length
- Vertical current distribution in cabinet

PRODUCT ATTRIBUTES

- Product Type: Busbar
- Material: Copper
- Finish: Tin Plated

ADDITIONAL PRODUCT DETAILS

Schroff busbar is a metallic strip or bar, typically housed inside switchgear, panel boards, and busway enclosures for local high current power distribution.



North America

All locations
+1.763.422.2661
Chat with us:
schroff.nvent.com

Europe

Straubenhardt, Germany
+49.7082.794.0
Betschdorf, France
+33.3.88.90.64.90
Warsaw, Poland
+48.22.209.98.35
Assago, Italy
+39.02.932.7141
Chat with us:
schroff.nvent.com

Asia

Shanghai, China
+86.21.2412.6943
Qingdao, China
+86.532.8771.6101
Singapore
+65.6768.5800
Shin-Yokohama, Japan
+81.45.476.0271
Chat with us:
schroff.nvent.com

Middle East & India

Dubai, United Arab Emirates
+971.4.378.1700
Bangalore, India
+91.80.6715.2001
Istanbul, Turkey
+90.216.250.7374
Chat with us:
schroff.nvent.com



Our powerful portfolio of brands:
nVent.com **CADDY ERICO HOFFMAN RAYCHEM SCHROFF TRACER**