

10502-297 TIP-UP HANDLE REPLACEMENT PARTS, 180 MM

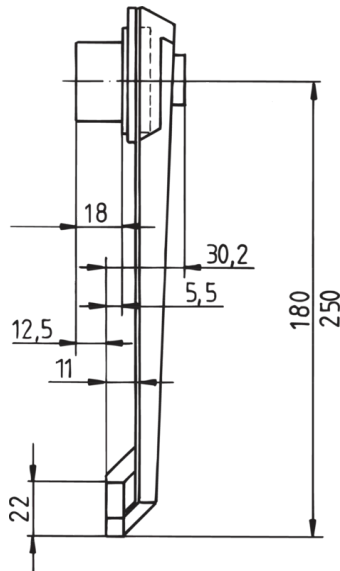

KEY FEATURES

Handle adjustable in 30° increments by push button

PRODUCT ATTRIBUTES

Product Type: Hardware Kit

Type: Tip-Up Handle Kit

Works With: Cases

Length: 180 mm

ADDITIONAL PRODUCT DETAILS

Assembly parts for handle bar.



North America

All locations
+1.763.422.2661
Chat with us:
schroff.nvent.com

Europe

Straubenhardt, Germany
+49.7082.794.0
Betschdorf, France
+33.3.88.90.64.90
Warsaw, Poland
+48.22.209.98.35
Assago, Italy
+39.02.932.7141
Chat with us:
schroff.nvent.com

Asia

Shanghai, China
+86.21.2412.6943
Qingdao, China
+86.532.8771.6101
Singapore
+65.6768.5800
Shin-Yokohama, Japan
+81.45.476.0271
Chat with us:
schroff.nvent.com

Middle East & India

Dubai, United Arab Emirates
+971.4.378.1700
Bangalore, India
+91.80.6715.2001
Istanbul, Turkey
+90.216.250.7374
Chat with us:
schroff.nvent.com



Our powerful portfolio of brands:
nVent.com **CADDY ERICO HOFFMAN RAYCHEM SCHROFF TRACER**