

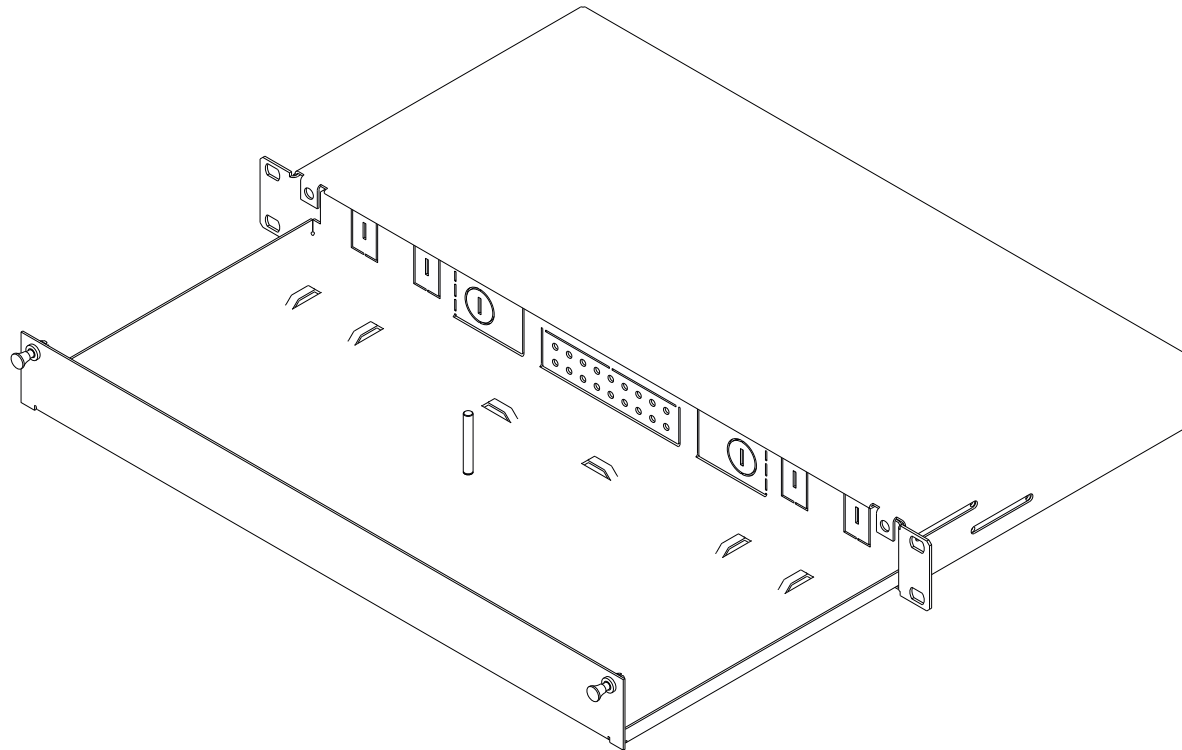

EasyLan® LWL Distribution Boxes / Splice Boxes



Notation:
You can find EasyLan® Quality Standards on separate data sheet

B A	Änderung Neuerstellung	06.11.2021 16.07.2018	MW JP	drawn	16.07.2018	L. Plödereder
				appr.	16.07.2018	M. Jungbeck
Index				Titel:		
Revision Code				EasyLan® FO Distribution Boxes / Splice Boxes		
Date				Drawing Number:		
Name				ZN-FO181416		
				 EasyLan® ...for a better connectivity		
				Dimensions: mm		
				Original: DIN A4		
				Sheet 1 of 14		

EasyLan® LWL Distribution Boxes / Splice Boxes

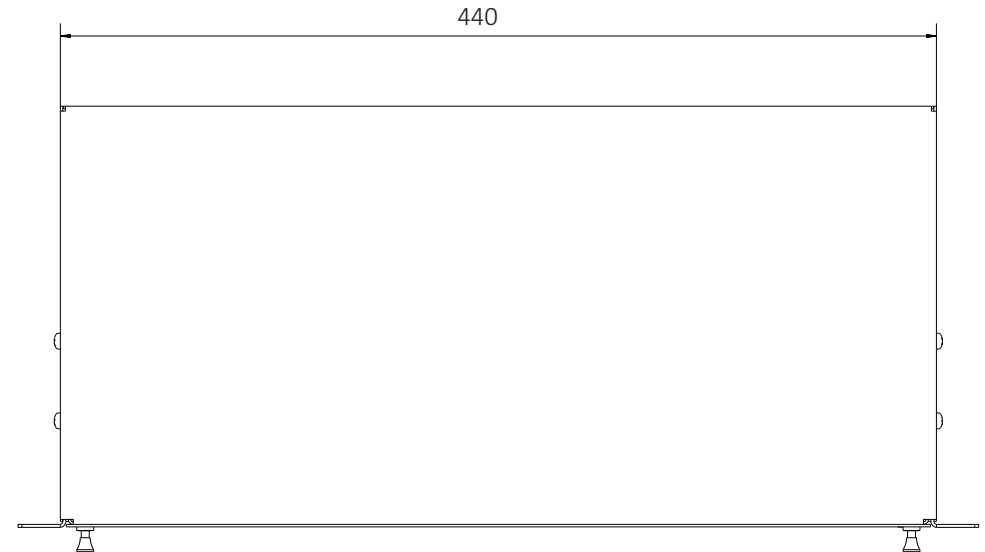
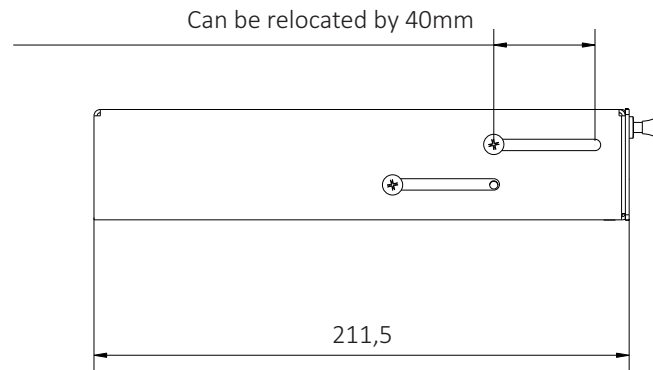
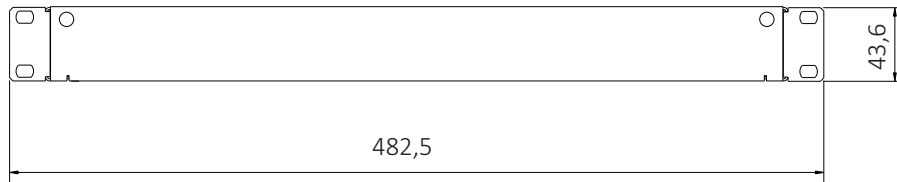

View: Back Side

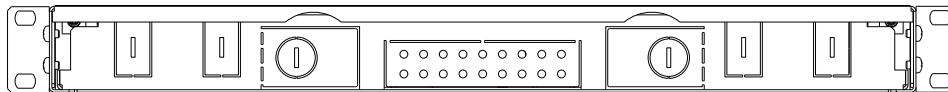

B A	Änderung Neuerstellung	06.11.2011 16.07.2018	MW LP	drawn	16.07.2018	L. Plödereder
				appr.	16.07.2018	M. Jungbeck
Index				Title:		
Revision Code				EasyLan® FO Distribution Boxes / Splice Boxes		
Date				Drawing Number:		
Name				ZN-FO181416		
				Dimensions: mm		
				Original: DIN A4		
				Sheet 2 of 14		



EasyLan® FO Front Plate 12x LC-Duplex / SC-Simplex

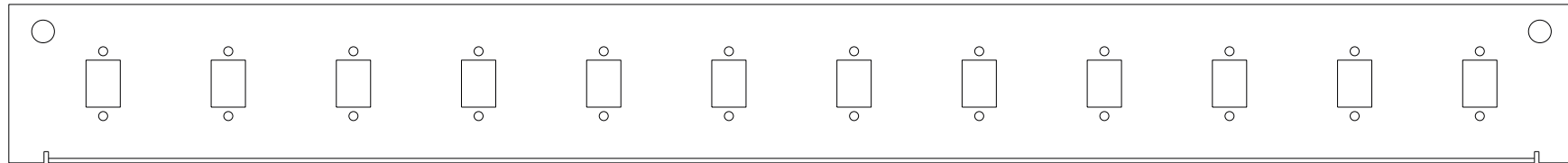

Possible Assembly:

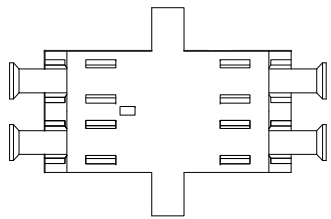

LC-Duplex, Grade C

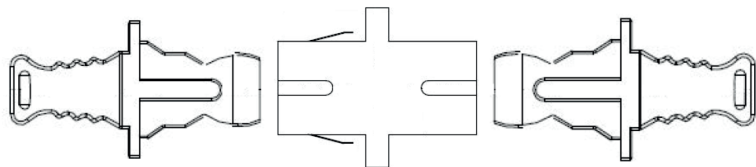

SC-Simplex, Grade B

Notation:

You can find EasyLan® Quality Standards on separate data sheet

B A	Änderung Neuerstellung	06.11.2018 16.07.2018	MW LP	drawn	16.07.2018	L. Plödereder	 EasyLan® ...for a better connectivity
				appr.	16.07.2018	M. Jungbeck	
Index				Title:		Dimensions: mm	
Revision Code				Drawing Number:		Original: DIN A4	
				ZN-FO181416		Sheet 3 of 14	

EasyLan® FO Front Plate 12x LC-Duplex Snap-In

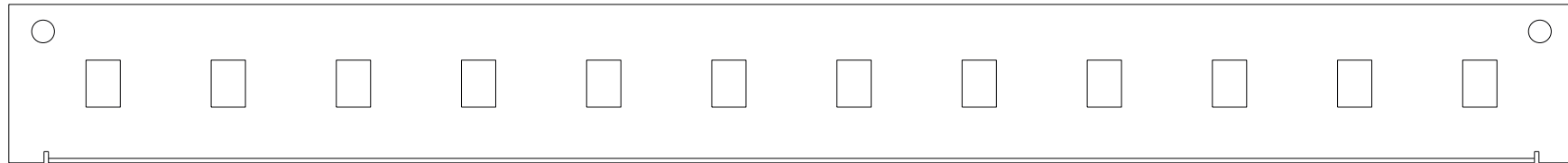

Possible Assembly:

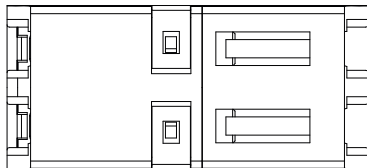

LC-Duplex, Grade B

Notation:

You can find EasyLan® Quality Standards on separate data sheet

B A	Änderung Neuerstellung	06.11.2011 16.07.2018	MW LP	drawn	16.07.2018	L. Plödereder	
				appr.	16.07.2018	M. Jungbeck	
Titel:				FO Front Plate 12x LC-Duplex / SC-Simplex			Dimensions: mm
Drawing Number:				ZN-FO181416			Original: DIN A4
Index	Revision Code	Date	Name				Sheet 4 of 14

EasyLan® FO Front Plate 24x LC-Duplex / SC-Simplex

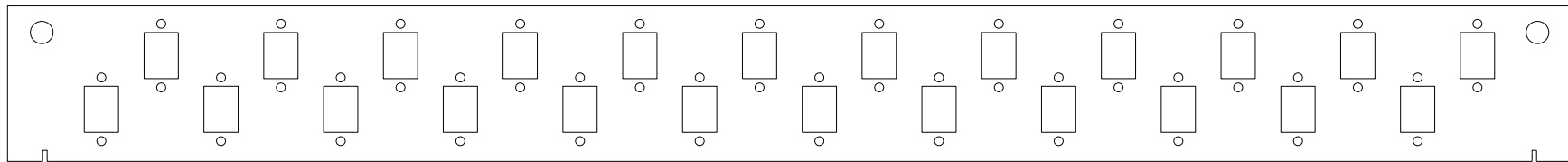

Possible Assembly:

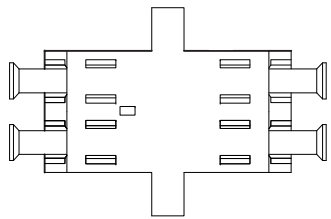

LC-Duplex, Grade C

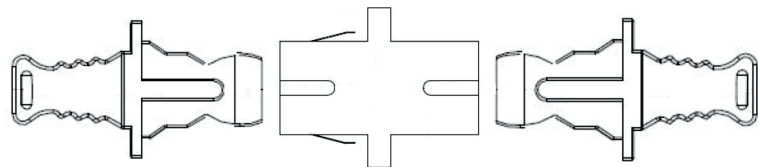

SC-Simplex, Grade B

Notation:

You can find EasyLan® Quality Standards on separate data sheet

B A	Änderung Neuerstellung	06.11.2011 16.07.2018	MW LP	drawn	16.07.2018	L. Plödereder	 ...for a better connectivity
				appr.	16.07.2018	M. Jungbeck	
Index				Title:		Dimensions: mm	
Revision Code				Date		Original: DIN A4	
Name				Drawing Number:		Sheet 5 of 14	
				ZN-FO181416			

EasyLan® FO Front Plate 24x LC-Duplex Snap-In

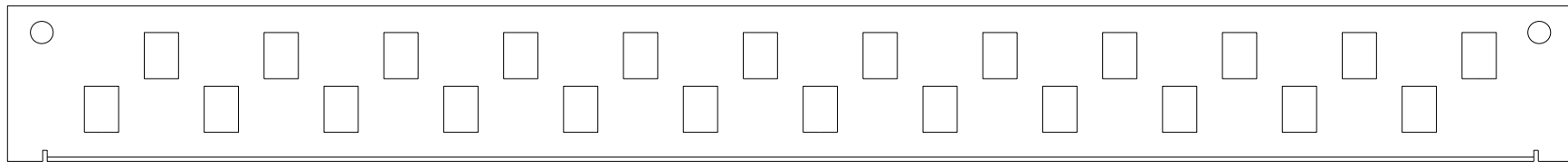

Possible Assembly:

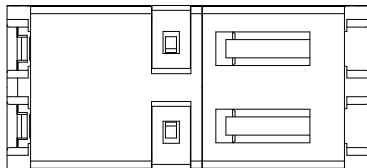

LC-Duplex, Grade B

Notation:

You can find EasyLan® Quality Standards on separate data sheet

B A	Änderung Neuerstellung	06.11.2018 16.07.2018	MW LP	drawn	16.07.2018	L. Plödereder
				appr.	16.07.2018	M. Jungbeck
Index				Titel:		
Revision Code				FO Front Plate 24x LC-Duplex / SC-Simplex		
Date				Drawing Number:		
Name				ZN-FO181416		
				 EasyLan® ...for a better connectivity		
				Dimensions: mm		
				Original: DIN A4		
				Sheet 6 of 14		

EasyLan® FO Front Plate 12x SC-Duplex / LC-Quad

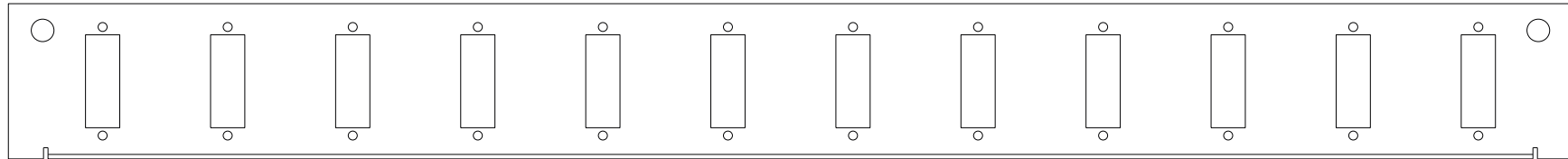

Possible Assembly:

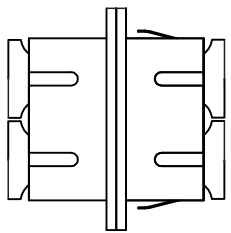

SC-Duplex, Grade C

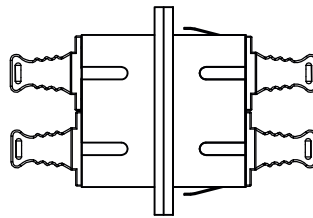

SC-Duplex, Grade B

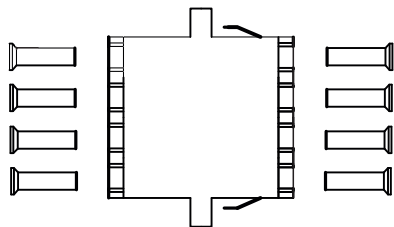

LC-Quad, Grade C

Notation:

You can find EasyLan® Quality Standards on separate data sheet

B A	Änderung Neuerstellung	06.11.2011 16.07.2018	MW LP	drawn	16.07.2018	L. Plödereder							
				appr.	16.07.2018	M. Jungbeck							
Index				Revision Code		Date		Name		Titel: FO Front Plate 12x SC-Duplex / LC-Quad		Dimensions: mm	
								Drawing Number:		ZN-FO181416		Original: DIN A4	
												Sheet 7 of 14	

EasyLan® FO Front Plate 12x LC-Quad Snap-In

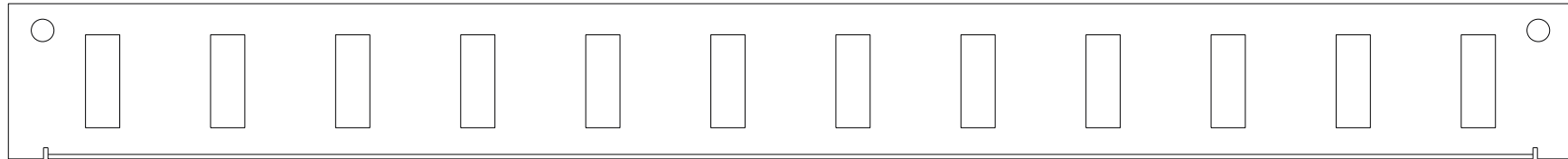

Possible Assembly:

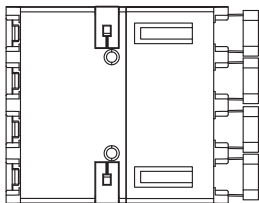

LC-Quad, Grade B

Notation:

You can find EasyLan® Quality Standards on separate data sheet

B A	Änderung Neuerstellung	06.11.2021 16.07.2018	MW LP	drawn	16.07.2018	L. Plödereder
				appr.	16.07.2018	M. Jungbeck
Index				Title:		
Revision Code				FO Front Plate 12x LC-Quad Snap-In		
Date				Drawing Number:		
Name				ZN-FO181416		
				 EasyLan® <i>...for a better connectivity</i>		
				Dimensions: mm		
				Original: DIN A4		
				Sheet 8 of 14		

EasyLan® FO Front Plate 24x SC-Duplex / LC-Quad

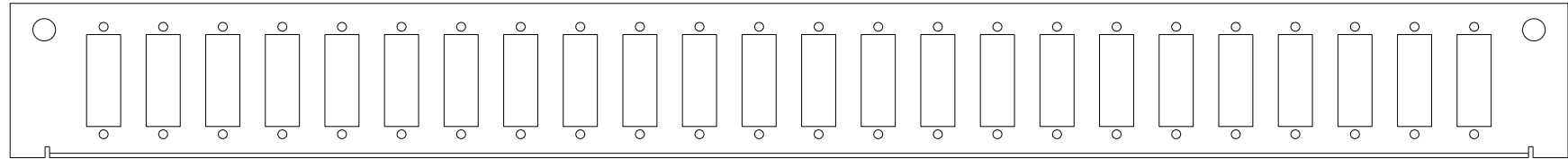

Possible Assembly:

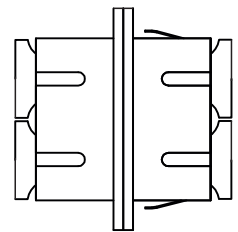

SC-Duplex, Grade C

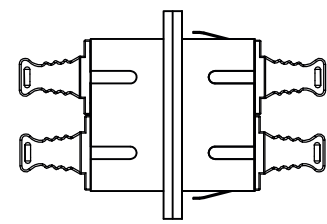

SC-Duplex, Grade B

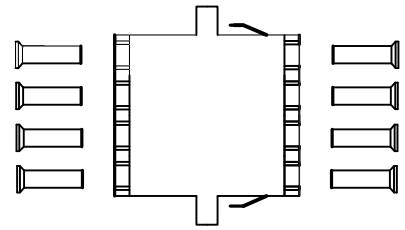

LC-Quad, Grade C

Notation:

You can find EasyLan® Quality Standards on separate data sheet

B A	Änderung Neuerstellung	06.11.2021 16.07.2018	MW LP	drawn	16.07.2018	L. Plödereder			
				appr.	16.07.2018	M. Jungbeck			
Index				Revision Code		Date	Name	Titel: FO Front Plate 24x SC-Duplex / LC-Quad	Dimensions: mm
								Drawing Number: ZN-FO181416	Original: DIN A4
									Sheet 9 of 14

EasyLan® FO Front Plate 24x LC-Quad Snap-In

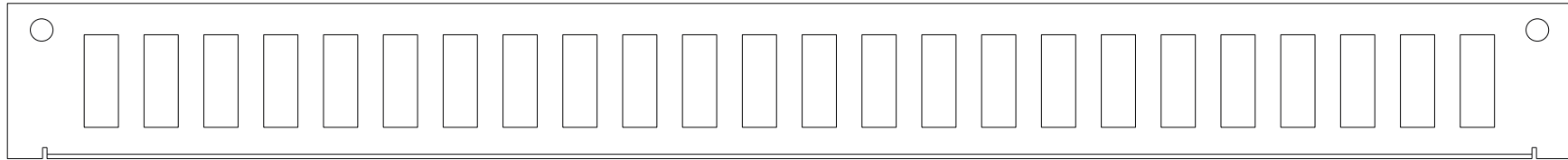

Possible Assembly:

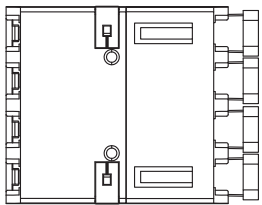

LC-Quad, Grade B

Notation:

You can find EasyLan® Quality Standards on separate data sheet

B A	Änderung Neuerstellung	06.11.2021 16.07.2018	MW LP	drawn	16.07.2018	L. Plödereder	
				appr.	16.07.2018	M. Jungbeck	
Index				Title:		Dimensions: mm	
Revision Code				FO Front Plate 24x LC-Quad Snap-In		Original: DIN A4	
Date				Drawing Number:		Sheet 10 of 14	
Name				ZN-FO181416			

EasyLan® Front Plate 12x E2000® Compact

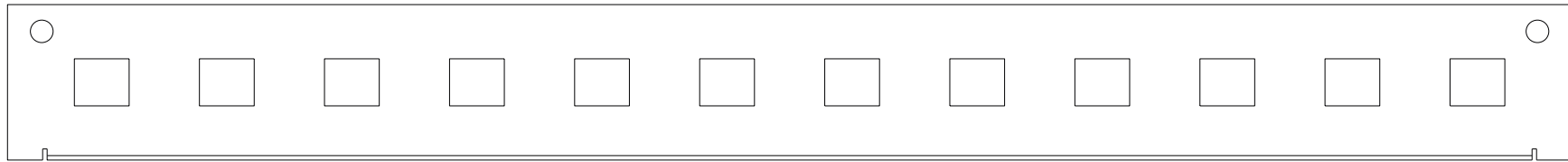

Possible Assembly:

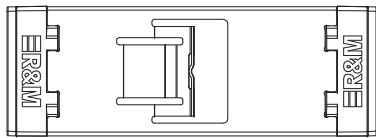

E2000® Compact (R&M),
Grade B



E2000® Compact (s4u),
Grade B

Notation:

You can find EasyLan® Quality Standards on separate data sheet

B A	Änderung Neuerstellung	06.11.2018 16.07.2018	MW LP	drawn	16.07.2018	L. Plödereder
				appr.	16.07.2018	M. Jungbeck
Title:				FO Front Plate 12x E2000® Compact		
Drawing Number:				ZN-FO181416		
Index				Sheet 11 of 14		



Dimensions: mm

Original: DIN A4

EasyLan® FO Front Plate 24x E2000® Compact

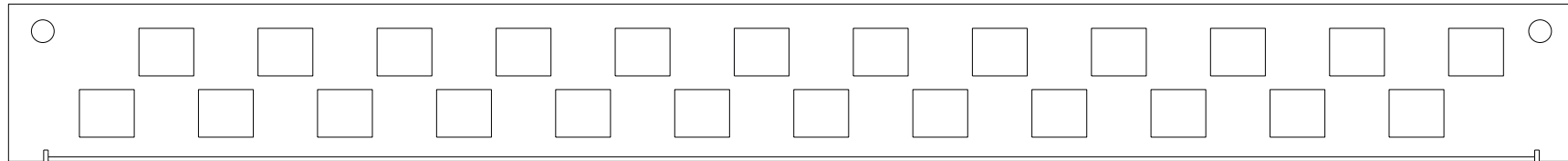

Possible Assembly:

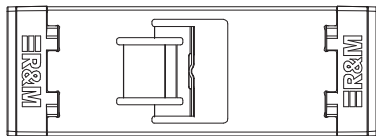

E2000® Compact (R&M),
Grade B



E2000® Compact (s4u),
Grade B

Notation:

You can find EasyLan® Quality Standards on separate data sheet

B A	Änderung Neuerstellung	06.11.2021 16.07.2018	MW LP	drawn	16.07.2018	L. Plödereder
				appr.	16.07.2018	M. Jungbeck
Title:				FO Front Plate 24x E2000® Compact		
Drawing Number:				ZN-FO181416		
Index	Revision Code	Date	Name	Dimensions: mm		
				Original: DIN A4		
				Sheet 12 of 14		



EasyLan® FO Front Plate 12x ST / FC

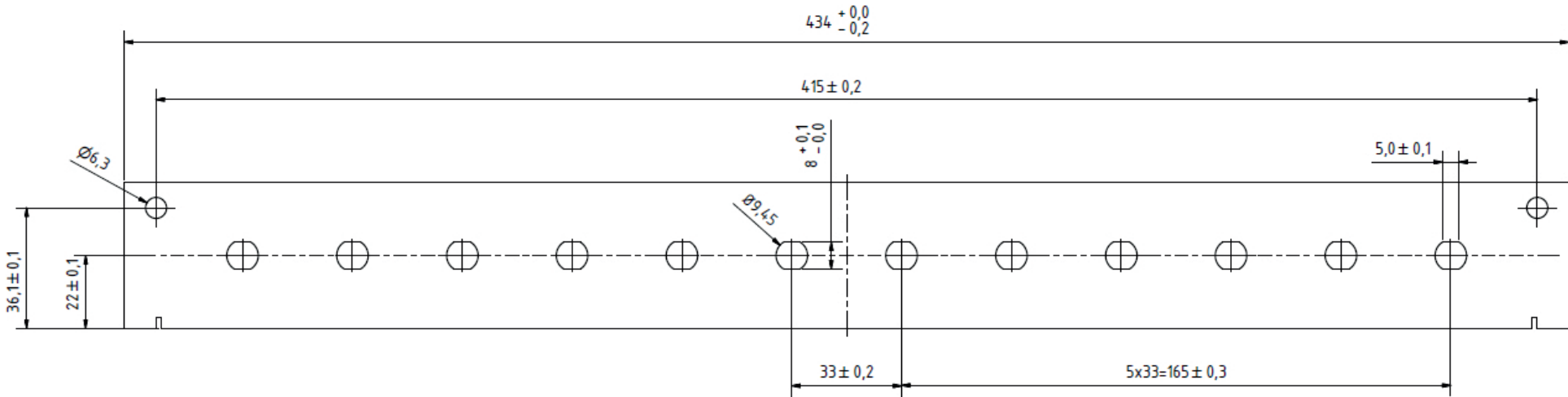

Notation:
 You can find EasyLan® Quality Standards on separate data sheet

B A	Änderung Neuerstellung	06.11.2021 16.07.2018	MW LP	drawn	16.07.2018	L. Plödereder
				appr.	16.07.2018	M. Jungbeck
Index				Titel:		
Revision Code				FO Front Plate 12x ST / FC		
Date				Drawing Number:		
Name				ZN-FO181416		
				 EasyLan® ...for a better connectivity		
				Dimensions: mm		
				Original: DIN A4		
				Sheet 13 of 14		

EasyLan® FO Front Plate 24x ST / FC

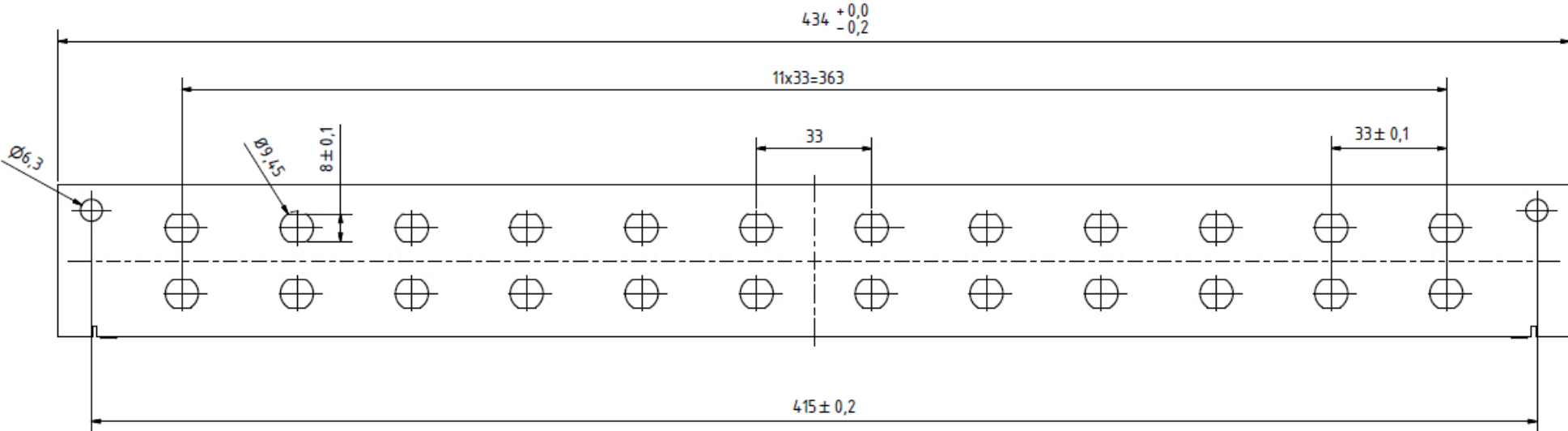

Notation:
 You can find EasyLan® Quality Standards on separate data sheet

B A	Änderung Neuerstellung	06.11.2011 16.07.2018	MW LP	drawn	16.07.2018	L. Plödereder
				appr.	16.07.2018	M. Jungbeck
Index				Titel: FO Front Plate 24x ST / FC Drawing Number: ZN-FO181416		
				 EasyLan® ...for a better connectivity		
				Dimensions: mm		
				Original: DIN A4		
				Sheet 14 of 14		