

Pendant Mount Installation

The MOBOTIX MOVE SpeedDome can be mounted under a ceiling (pendant mounted) with the accessory: Mx-M-SD-PM(EXT).

Pendant Mount Mx-M-SD-PM (EXT)

Iron; Height: 290.0 / 540.0 / 1040.0 mm (11.4 / 21.3 / 40.9 inches);

Weight: 1.5 kg (3.3 lbs) / 1.8 kg (4.0 lbs) / 3.0 kg (6.6 lbs); Diameter: 50.4 mm (2.0 inches)

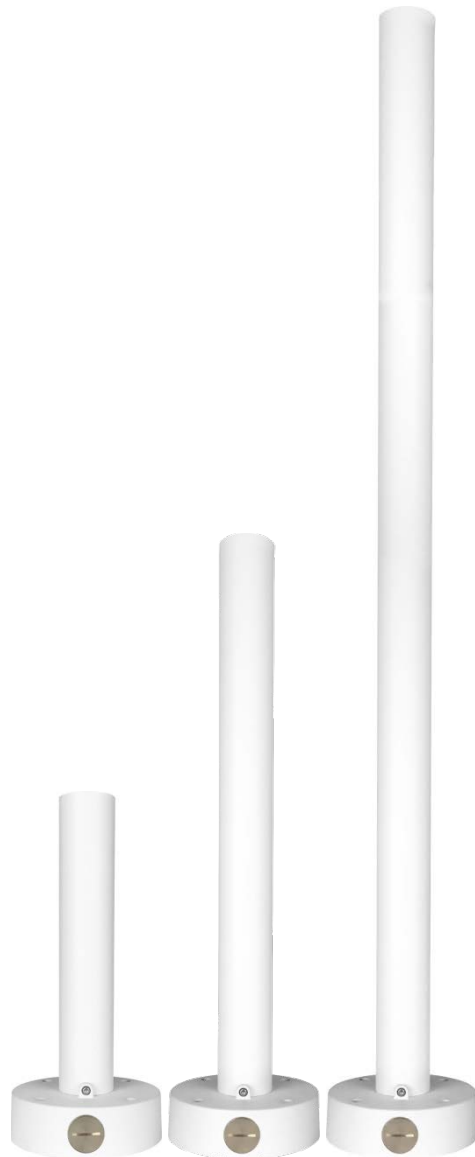

Pendant Mount w. extension pipes
(Mx-M-SC-PMEXT optional)

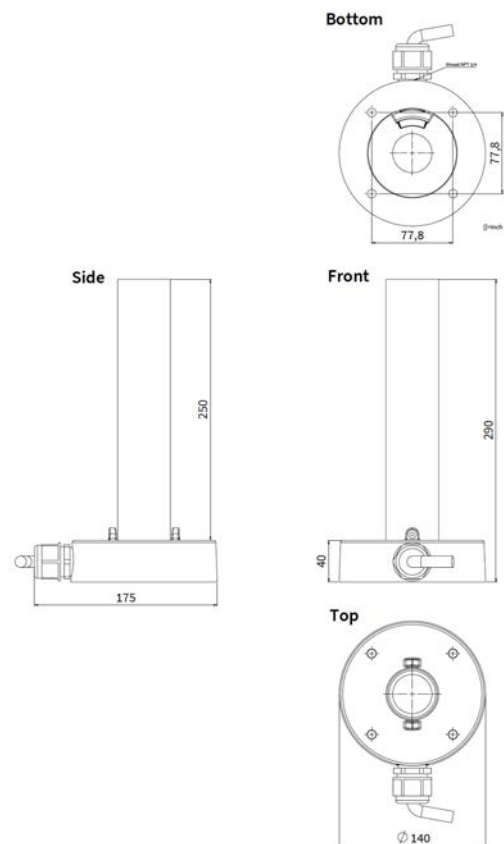

The pendant Mount Kit Mx-M-SD-PM is supporting a basic length of 250mm. It can be extended by the usage of the optional pendant mount extension pipes Mx-M-SD-PMEXT to 500mm, 750mm and max. 1000mm.

Package Contents:

- Cable Gland
- Rubber Ring (Thicker; for Cable Gland)
- Rubber Ring (Thinner; for Conduit Entry Block)
- O-ring (88.6mm in diameter; for Base Bracket)
- O-ring (34.4mm in diameter; for Straight Tube)
- 5/16" x 54mm Mechanical Screw (x4)
- Screw Nut (x4)
- M6x16mm Mechanical Screw (for Anti-drop Wire)
- M4x6mm Mechanical Screw (x2) (for Straight Tube fixation)
- 3x Anti-Drop Wire (different length support)

Optional Items Needed:

- Extension Tube Mx-M-SD-PMEXT (option)

Tools / Installation Material needed:

- Tools for drilling and screwing / fixation
- PTFE Thread Seal Tape

Follow the steps (**Method A or Method B**) to mount the PTZ Camera with Pendant Mount.

Method A (“Rear” Cable Entry / through Ceiling)

Step 1:

Ensure that the ceiling panel can support the weight of the PTZ Camera and Straight Tube.

Step 2:

Install the supplied O-ring (88.6mm in diameter) on the base bracket.

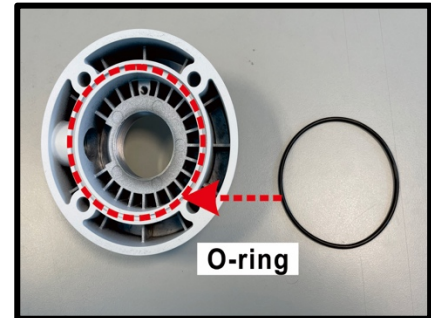

Step 3:

Place the base bracket at the installation location. Mark the position of the **four screw holes** and the **cable entry hole** on the ceiling.

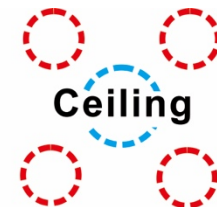
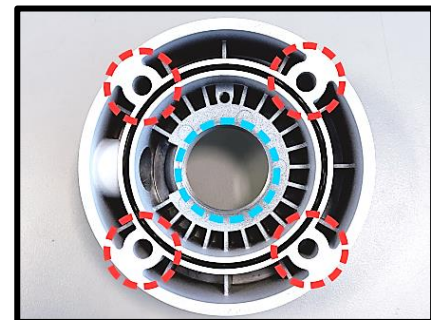

Step 4:

On the ceiling, drill four screw holes and one cable entry hole. Then push the cable(s) through the cable entry hole.

Step 5:

Screw the anti-drop chain to the base bracket and pass the chain through the back entry hole.

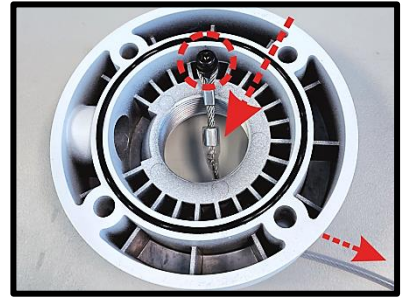

Step 6:

Pass the cables through the back entry hole. Fix the base bracket to the ceiling with supplied 5/16" x 54mm mechanical screws and screw nuts.

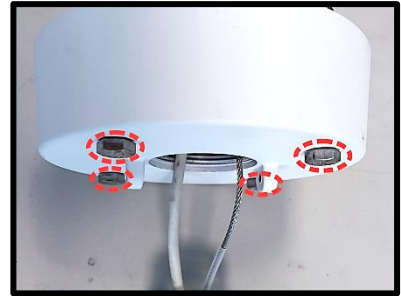

Step 7:

Install the supplied O-ring (34.4mm in diameter) on the straight tube.

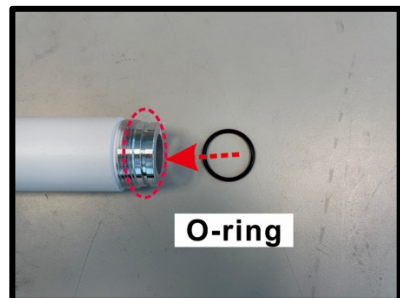

Step 8:

Pass the cables and anti-drop chain through the Straight Tube.

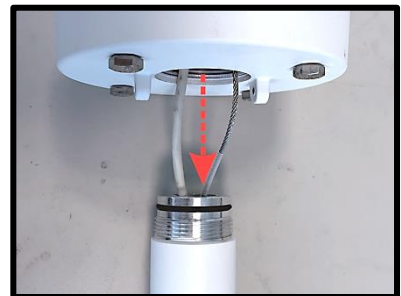

Step 9:

Rotate the Straight Tube clockwise to the base bracket. Then tighten the Straight Tube with two screws.

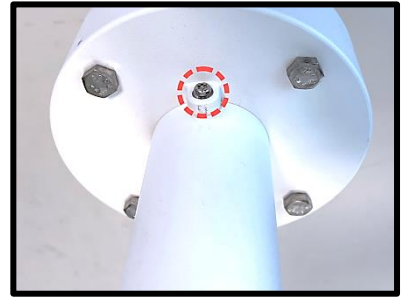

Step 10:

Coat the PTFE thread seal tape (not supplied) to the thread of mounting kit around five times for waterproof purpose as the right figure.

Then thread the Ethernet cable and other cables through the mounting kit and fix the mounting kit to the Straight Tube.



Step 11:

Connect the cables to the PTZ Camera.

Step 12:

Fix the camera to the mounting kit with the supplied screw and washers.

Installation completed.



Method B (Side Conduit Entry)

Step 1:

Ensure that the ceiling panel can support the weight of the PTZ Camera and Straight Tube.

Step 2:

Install the supplied O-ring (88.6mm in diameter) on the base bracket.

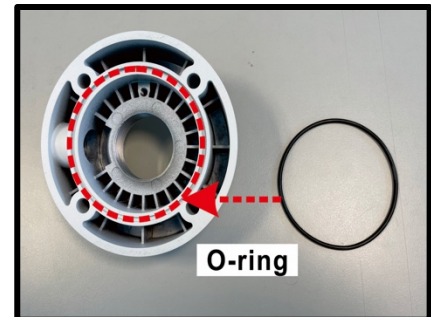

Step 3:

Place the base bracket at the installation location. Mark the position of the **four screw holes** on the ceiling.

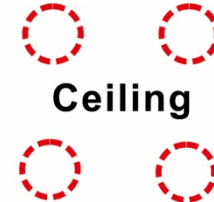
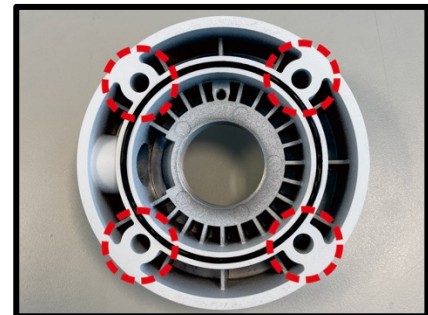

Step 4:

On the ceiling, drill four screw holes.

Step 5:

Screw the anti-drop chain to the base bracket and pass the chain through the back entry hole.

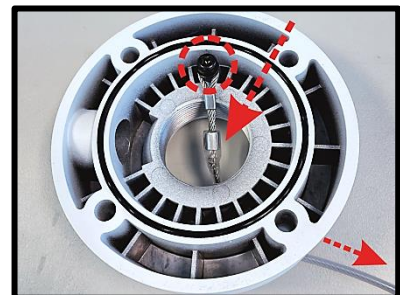

Step 6:

To use the side conduit entry for cable connection, please use a coin or screwdriver to open the conduit entry block.

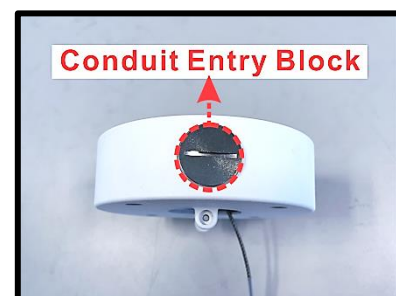



Step 7:

Thread the required cables through (1) the cable gland and (2) the conduit entry hole.

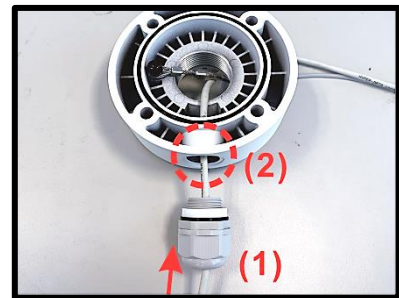

NOTE: For the cable gland installation, please follow the steps below:

Step (a):

Pass the supplied thicker rubber ring through the cable gland



Step (b):

Loosen the thread-lock sealing nut from the cable gland body.



Step (c):

Insert the required cables, e.g., Ethernet cable, to the thread-lock sealing nut and the cable gland body from the bottom.



Step (d):

Twist the cable gland body a little bit back to the thread-lock sealing nut but not entirely tightened.



Step 8:

Adjust the cables and twist the cable gland into the side conduit entry hole. Then pass the cables through the back cable entry hole of base bracket.

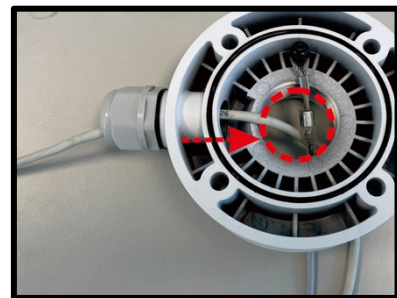

Step 9:

Fix the base bracket to the ceiling with supplied 5/16" x 54mm mechanical screws and screw nuts.

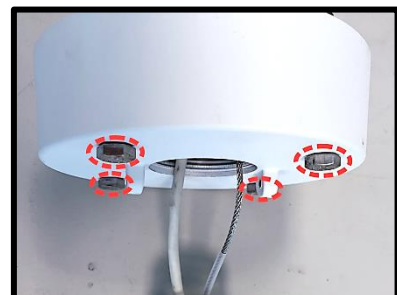

Step 10:

Install the supplied O-ring (34.4mm in diameter) on the straight tube.

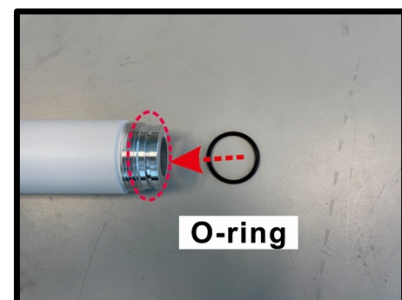

Step 11:

Pass the cables and anti-drop chain through the Straight Tube.

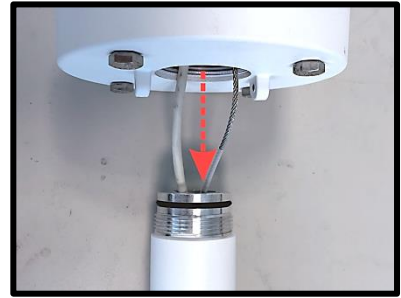

Step 12:

Rotate the Straight Tube clockwise to the base bracket. Then tighten the Straight Tube with two screws.

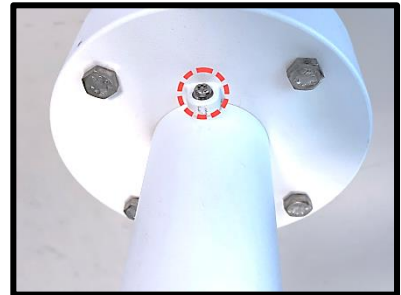

Step 13:

Coat the PTFE thread seal tape (not supplied) to the thread of mounting kit around five times for waterproof purpose as the right figure.

Then thread the Ethernet cable and other cables through the mounting kit and fix the mounting kit to the Straight Tube.



Step 14:

Connect the cables to the PTZ Camera.

Step 15:

Fix the camera to the mounting kit with the supplied screw and washers.

Installation completed.



Important:

Ensure that all mounting screws are fixed firmly to prevent equipment to fall off and avoid injuries. We recommend checking the proper installation along annual maintenance intervals. In case of visible “damage”, please immediately replace component!